

Ersatzteilliste-Explosionszeichnung

MORETTI Elektro-Pizzaofen iDeck M 65.105 Digital

[Art. 493065105111]

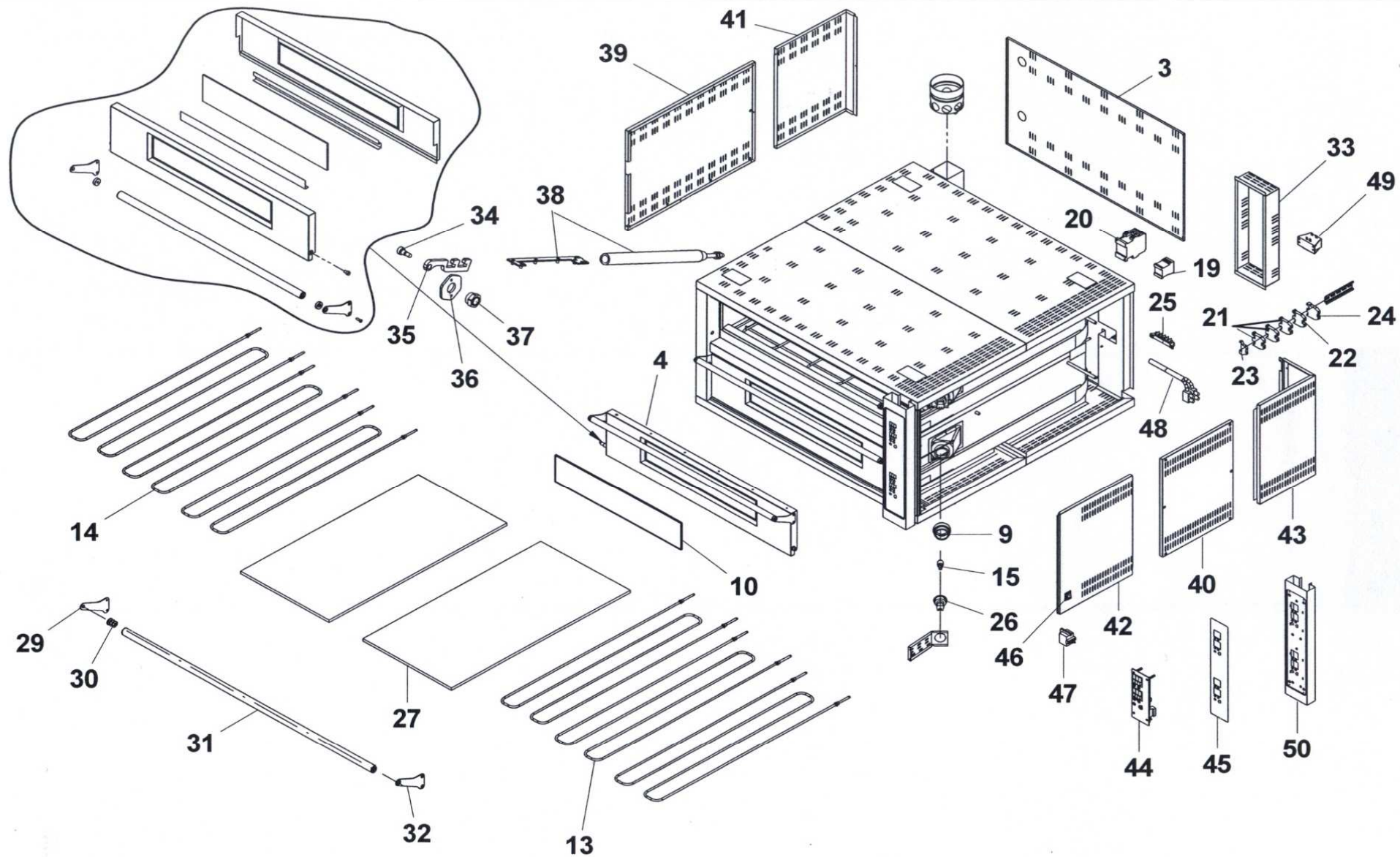



iD 72.72 M/D - 65.105 M/D - 105.65 M/D - 105.105 M/D

Codice esploso - Exploded view code - Code vue éclatée - Explosionszeichnung Kode - Código grupo

73301810 06

#	Tipo Type Type Type Tipo	Codice Code Code Kode Codigo	DESCRIZIONE	Description Description Beschreibung Descripción	
3	105.65/105.105 MONO	50703240	PANNELLO POSTERIORE	Extractable back panel - Panneau extraible posterieur - Herausziehbarer Rückpaneel - Panel posterior extraíble	
3	105.65/105.105 DUO	50703330	PANNELLO POSTERIORE	Extractable back panel - Panneau extraible posterieur - Herausziehbarer Rückpaneel - Panel posterior extraíble	
3	65.105 MONO	50703370	PANNELLO POSTERIORE	Extractable back panel - Panneau extraible posterieur - Herausziehbarer Rückpaneel - Panel posterior extraíble	
3	65.105 DUO	50704350	PANNELLO POSTERIORE	Extractable back panel - Panneau extraible posterieur - Herausziehbarer Rückpaneel - Panel posterior extraíble	
3	72.72 MONO	50702360	PANNELLO POSTERIORE	Extractable back panel - Panneau extraible posterieur - Herausziehbarer Rückpaneel - Panel posterior extraíble	
3	72.72 DUO	50702310	PANNELLO POSTERIORE	Extractable back panel - Panneau extraible posterieur - Herausziehbarer Rückpaneel - Panel posterior extraíble	
4	105.65/105.105	68002820	A. SPORTELLO PIZZY 105.65 105.105 CON MANIGLIONE	Complete door - Porte complète - Komplette Tür - Puerta completa	
4	65.105	68006010	A. SPORTELLO PIZZY 65.105 CON MANIGLIONE	Complete door - Porte complète - Komplette Tür - Puerta completa	
4	72.72	68008590	A. SPORTELLO 72.72 CON MANIGLIONE	Complete door - Porte complète - Komplette Tür - Puerta completa	
9		73700690	CALOTTA IN VETRO FILETTATA D.74	Glass calotte - Calotte en verre - Glasschutzhaube - Tapa di vidrio	
10	105.65/105.105	73700840	VETRO TEMPRATO MOLATO AI BORDI DA 697x135x5 (46800000)	Tempered glass - Verre Trempé - Gehärtetesglas - Vidrio templado	
10	72,72/65.105	73700850	VETRO TEMPRATO MOLATO AI BORDI DA 385x135x5 (46800010)	Tempered glass - Verre Trempé - Gehärtetesglas - Vidrio templado	

iD 72.72 M/D - 65.105 M/D - 105.65 M/D - 105.105 M/D

Codice esploso - Exploded view code - Code vue éclatée - Explosionszeichnung Kode - Codigo grupo

73301810 06

#	Tipo Type Type Type Tipo	Codice Code Code Kode Codigo	DESCRIZIONE	Description Description Beschreibung Descripción	
13	65.105	74400160	RESISTENZA CORAZZATA PLATEA 65.105 W920 V230	Armored heating element-bottom - Résistance blindée-sole - Gepanzerte Heizelement-boden - Resistencia blindada-suelo	
13	105.105	74400390	RESISTENZA CORAZZATA PLATEA 105.105 W1456 V230	Armored heating element-bottom - Résistance blindée-sole - Gepanzerte Heizelement-boden - Resistencia blindada-suelo	
13	105.65	74400400	RESISTENZA CORAZZATA PLATEA 105.65 W972 V230	Armored heating element-bottom - Résistance blindée-sole - Gepanzerte Heizelement-boden - Resistencia blindada-suelo	
13	72.72	74401580	RESISTENZA CORAZZATA PLATEA 72.72 (W800 V230)	Armored heating element-bottom - Résistance blindée-sole - Gepanzerte Heizelement-boden - Resistencia blindada-suelo	
14	65.105	74400180	RESISTENZA CORAZZATA CIELO 65.105 W1650 V230	Armored heating element-top - Résistance blindée-voûte - Gepanzerte Heizelement-decke - Resistencia blindada-techo	
14	105.65	74400250	RESISTENZA CORAZZATA CIELO 105.65 W1750 V230	Armored heating element-top - Résistance blindée-voûte - Gepanzerte Heizelement-decke - Resistencia blindada-techo	
14	105.105	74400280	RESISTENZA CORAZZATA CIELO 105.105 W2400 V230	Armored heating element-top - Résistance blindée-voûte - Gepanzerte Heizelement-decke - Resistencia blindada-techo	
14	72.72	74401560	RESISTENZA CORAZZATA CIELO 72.72 (W1200 V230)	Armored heating element-top - Résistance blindée-voûte - Gepanzerte Heizelement-decke - Resistencia blindada-techo	
15		74401460	LAMPADINA 40W 230V G9 (OSRAM)	Bulb W40 V220 G9 - Ampoule W40 V220 G9 - Lampe W40 V220 G9 - Lámpara W40 V220 G9	
19		74550230	CONTATTORE 3RT10 16-1AP01 230V 50/60Hz 20A	Contactor - Contacteur - Kontaktgeber - Contactor	
20	105.105 V230 3 (platea)	74550500	CONTATTORE 3RT10 24-1AP00 230V 50/60 Hz 35A	Contactor - Contacteur - Kontaktgeber - Contactor	
21	72.72/65.105/105.105/105.65 DUO V230; 105.105 DUO V400	74610020	MORSETTI DA 35mmq X BASE OMEGA 8WA1 205	Terminals - Bornes - Klammer - Bornes	

iD 72.72 M/D - 65.105 M/D - 105.65 M/D - 105.105 M/D

Codice esploso - Exploded view code - Code vue éclatée - Explosionszeichnung Kode - Codigo grupo

73301810 06

#	Tipo Type Type Type Tipo	Codice Code Code Kode Codigo	DESCRIZIONE	Description Description Beschreibung Descripción	
22	105.105 DUO V400	74610070	MORSETTI DA 10mmq PER BASE OMEGA 3 (37064)	Terminals - Bornes - Klammer - Bornes	
23	72.72/65.105/105.65 /105.105 DUO V230; 105.105 DUO V400	74610080	MORSETTO DI BLOCCAGGIO SU BASE OMEGA 3 (39403- LEG)	Terminals - Bornes - Klammer - Bornes	
24	72.72/65.105/105.65 /105.105 DUO V230; 105.105 DUO V400	74610190	MORSETTO DA 10mmq PER BASE OMEGA GIALLO- VERDE	Terminals - Bornes - Klammer - Bornes	
25		74610340	MORSETTIERA A 6 POLI FV122	Terminals board - Platine des bornes - Klemmkaste - Bornera	
26		74700200	PORTALAMPADA ATTACCO G9 (BJB 77.718.U101.10)	Lamp holder - Douille - Lampenfassung - Portalámparas	
27	105.105	76000090	TAVELLA IN REFRATTARIO 526X1056X14 SABBIATA (49100030)	Refractory brick flat tile - Brique plate en réfractaire - Schamottplatte - Ladrillo refractario	
27	65.105/105.65	76000110	TAVELLA IN REFRATTARIO 526X658X14 SABBIATA (49100040)	Refractory brick flat tile - Brique plate en réfractaire - Schamottplatte - Ladrillo refractario	
27	72.72	76000950	TAVELLA IN REFRA. 361x720x14	Refractory brick flat tile - Brique plate en réfractaire - Schamottplatte - Ladrillo refractario	
29		72063150	ATTACCO SINISTRO MANIGLIA SPORTELLO	Handle left connection - Connexion poignée gauche - Linke Klinkeverbindung - Conexión manija izquierda	
30		72501590	INSERTO ITT2T/M 8/21,4 C.N. TONDO C/FL. ZINC.BIANCA	Round insert - insertion tonde - Rundbeilage - Inserción redonda	
31	105.65/105.105	72009830	MANIGLIONE PER SPORTELLO	Handle - Poignée - Klinke - Manija	
31	65.105	72053910	MANIGLIONE PER SPORTELLO	Handle - Poignée - Klinke - Manija	

iD 72.72 M/D - 65.105 M/D - 105.65 M/D - 105.105 M/D

Codice esploso - Exploded view code - Code vue éclatée - Explosionszeichnung Kode - Codigo grupo

73301810 06

#	Tipo Type Type Type Tipo	Codice Code Code Kode Codigo	DESCRIZIONE	Description Description Beschreibung Descripción	
31	72.72	72014300	MANIGLIONE PER SPORTELLO	Handle - Poignée - Klinke - Manija	
32		72009500	ATTACCO DESTRO MANIGLIA SPORTELLO	handle right connection - Connexion poignée droite - Klinkerechteverbindung - Conexión manija derecha	
33	MONO	50704790	COPERCHIO POSTERIORE CONTATTORI	Rear cover contactors - Coverche postérieur contacteurs - Kontaktgeberhinterdecke - Tapa posterior contactores	
33	DUO	50704850	COPERCHIO POSTERIORE CONTATTORI	Rear cover contactors - Coverche postérieur contacteurs - Kontaktgeberhinterdecke - Tapa posterior contactores	
34		72125590	VITE TCEI M 8 GAMBO RETTIFICATO M8 d10 L10	Screw - Vis - Schraube - Tornillo	
35		66001730	A. ATTACCO MOLLA-LEVA SPORTELLO	Lever-spring connection - Connexion ressort-levier - Hebel Federverbindungskomponente - Conexión muelle palanca	
36		72009460	DADO FISSAGGIO BOCCOLA M25X1,5	Bush fixing nut - Écron pour fixation douille - Büchsebefestigungsmutter - Tuerca por fijar buje	
37		66002330	ASSIEME BOCCOLA SPORTELLO	Door bush whole - Douille ensemble pour porte - Türbüchsekomponente - Comjunto anillo por puerta	
38	72.72/105.65	66002300	ASSIEME MOLLA COMPLETA DI OCCHIELLO	Spring with hole - Ensemble ressort avec boutonniere - Federkomponente mit Ose - Junto muella con ojal	
38	65.105/105.105	66002310	ASSIEME MOLLA COMPLETA DI OCCHIELLO	Spring with hole - Ensemble ressort avec boutonniere - Federkomponente mit Ose - Junto muella con ojal	
39	65.105/105.65/105.105 MONO	50701450	PANNELLO LAT. SX. ANTERIORE	Front left side panel - Panneau frotal lateral gauche - Linken Vorderseitenerpaneel - Panel frontal lateral izquierdo	
39	65.105/105.65/105.105 DUO	50701460	PANNELLO LAT. SX. ANTERIORE	Front left side panel - Panneau frotal lateral gauche - Linken Vorderseitenerpaneel - Panel frontal lateral izquierdo	

iD 72.72 M/D - 65.105 M/D - 105.65 M/D - 105.105 M/D

Codice esploso - Exploded view code - Code vue éclatée - Explosionszeichnung Kode - Codigo grupo

73301810 06

#	Tipo Type Type Type Tipo	Codice Code Code Kode Codigo	DESCRIZIONE	Description Description Beschreibung Descripción	
40	72.72/65.105/105.65/105.105 DUO	50701320	PANNELLO LAT. DX. CENTRALE	Central right side panel - Panneau central lateral droite - Rechten Hinterseitenerpaneel - Panel lateral central derecho	
40	72.72/65.105/105.65/105.105 MONO	50701340	PANNELLO LAT. DX. CENTRALE	Central right side panel - Panneau central lateral droite - Rechten Hinterseitenerpaneel - Panel lateral central derecho	
41	65.105/105.105 DUO	50701470	PANNELLO LAT. SX. POSTERIORE	Rear left side panel - Panneau postérieur lateral gauche - Linken Hinterseitenerpaneel - Panel lateral posterior izquierdo	
41	65.105/105.105 MONO	50701480	PANNELLO LAT. SX. POSTERIORE	Rear left side panel - Panneau postérieur lateral gauche - Linken Hinterseitenerpaneel - Panel lateral posterior izquierdo	
41	105.65 MONO	50701490	PANNELLO LAT. SX. POSTERIORE	Rear left side panel - Panneau postérieur lateral gauche - Linken Hinterseitenerpaneel - Panel lateral posterior izquierdo	
41	105.65 DUO	50701500	PANNELLO LAT. SX. POSTERIORE	Rear left side panel - Panneau postérieur lateral gauche - Linken Hinterseitenerpaneel - Panel lateral posterior izquierdo	
42	65.105/105.105 DUO	50701310	PANNELLO LAT. DX. ANTERIORE	Front right side panel - Panneau frotal lateral droite - Rechten Vorderseitenerpaneel - Panel frontal lateral derecho	
42	65.105/105.105 MONO	50701350	PANNELLO LAT. DX. ANTERIORE	Front right side panel - Panneau frotal lateral droite - Rechten Vorderseitenerpaneel - Panel frontal lateral derecho	
42	72.72/105.65 MONO	50701370	PANNELLO LAT. DX. ANTERIORE	Front right side panel - Panneau frotal lateral droite - Rechten Vorderseitenerpaneel - Panel frontal lateral derecho	
42	72.72/105.65 DUO	50701400	PANNELLO LAT. DX. ANTERIORE	Front right side panel - Panneau frotal lateral droite - Rechten Vorderseitenerpaneel - Panel frontal lateral derecho	
43	65.105/105.105 DUO	50701330	PANNELLO LAT. DX. POSTERIORE	Rear right side panel - Panneau postérieur lateral droite - Rechten Hinterseitenerpaneel - Panel lateral posterior derecho	
43	65.105/105.105 MONO	50701360	PANNELLO LAT. DX. POSTERIORE	Rear right side panel - Panneau postérieur lateral droite - Rechten Hinterseitenerpaneel - Panel lateral posterior derecho	

iD 72.72 M/D - 65.105 M/D - 105.65 M/D - 105.105 M/D

Codice esploso - Exploded view code - Code vue éclatée - Explosionszeichnung Kode - Codice grupo

73301810 06

#	Tipo Type Type Type Tipo	Codice Code Code Kode Codigo	DESCRIZIONE	Description Description Beschreibung Descripción	
43	105.65 MONO	50701380	PANNELLO LAT. DX. POSTERIORE	Rear right side panel - Panneau postérieur lateral droite - Rechten Hinterseitenerpaneel - Panel lateral posterior derecho	
43	105.65 DUO	50701390	PANNELLO LAT. DX. POSTERIORE	Rear right side panel - Panneau postérieur lateral droite - Rechten Hinterseitenerpaneel - Panel lateral posterior derecho	
43	72.72 MONO	50702340	PANNELLO LAT. DX. POSTERIORE	Rear right side panel - Panneau postérieur lateral droite - Rechten Hinterseitenerpaneel - Panel lateral posterior derecho	
43	72.72 DUO	50702320	PANNELLO LAT. DX. POSTERIORE	Rear right side panel - Panneau postérieur lateral droite - Rechten Hinterseitenerpaneel - Panel lateral posterior derecho	
44		74301300	PIROMETRO TERMOR iDeck LED BIANCHI	Pyrometer - Piromètre - Pyrometer - Pirómetro	
45	iD MONO	73503560	ETICHETTA QUADRO COMANDI iD/MONO NERO-ARGENTO	Label control panel - Etiquette-panneau de control - Etikett-Schalltafel - Tarjeta-panel de mando	
45	iD DUO	73503570	ETICHETTA QUADRO COMANDI iD/DUO NERO-ARGENTO	Label control panel - Etiquette-panneau de control - Etikett-Schalltafel - Tarjeta-panel de mando	
45	SIGMA MONO	73501770	ETICHETTA QUADRO COMANDI iD/M NEUTRA	Label control panel - Etiquette-panneau de control - Etikett-Schalltafel - Tarjeta-panel de mando	
45	SIGMA DUO	73501780	ETICHETTA QUADRO COMANDI iD/D NEUTRA	Label control panel - Etiquette-panneau de control - Etikett-Schalltafel - Tarjeta-panel de mando	
46		74500940	INT. BIP. LUM. BIANCO CORN/NERA 0/1 (40100I505-A83)	Switch - Interrupteur - Ausschalter - Interruptor	
47	JUMO	74300710	TERMOSTATO SIC. STB 500°C (60.2031/80 TN 00 541883)	Safety Thermostat - Thermostat de sécurité - Sicherheitsthermostat - Termostato de seguridad	
48		66081910	A. TERMOCOPPIA 110	Thermocouple - Thermocouple - Thermoelement - Termopar	

iD 72.72 M/D - 65.105 M/D - 105.65 M/D - 105.105 M/D

Codice esploso - Exploded view code - Code vue éclatée - Explosionszeichnung Kode - Codigo grupo

73301810 06

#	Tipo Type Type Type Tipo	Codice Code Code Kode Codigo	DESCRIZIONE	Description Description Beschreibung Descripción	
49		74110200	TRASFORMATORE 1123593 10VA 12V 230V CLASSE 2 UL	Transformer - Transformateur - Transformator - Transformador	
50	DUO	50215050	QUADRO COMANDI SPORGENTE	Prominent control board - Panneau de contrôle saillant - Vorstehend Steuerapparat - Panel de mando saliente	
50	MONO	50215070	QUADRO COMANDI SPORGENTE	Prominent control board - Panneau de contrôle saillant - Vorstehend Steuerapparat - Panel de mando saliente	

Via A.Meucci, 4 - 61037 - Mondolfo (PU) ITALIA
Tel. +39-0721-96161 - Fax +39-0721-9616299
[Http://www.morettiforni.com](http://www.morettiforni.com)

NordCap GmbH & Co. KG
Thalendorststraße 15
28307 Bremen
Hauptsitz (Service, Finanzen & Personal, Lager, IT, Marketing)

Telefon: +49 421 48557-0
Telefax: +49 421 488650
E-Mail: bremen@nordcap.de

Die NordCap Verkaufsniederlassungen in Deutschland:

Nord: Hamburg • Ost: Berlin • Süd: Ingelheim • West: Erkrath

by **NordCap**[®]

 **MORETTI
FORNI**
The SmartBaking Company[®]