

HOTELBAD-ACCESSOIRES / BATHROOM ACCESSORIES

**ALISEO**<sub>GmbH</sub>  
G E R M A N Y

# ALISEO BATHROOM ACCESSORIES

## DIFFERENT BATHROOMS ... DIFFERENT LOOKS

Aliseo's Badezimmer-Accessoires lassen sich individuell auf Ihre Badplanung abstimmen: die moderne NOW, die kraftvolle Architecto, die zeitlose Tecno und die einzigartige NEXXUS

\* Abweichende Ausführungen und Oberflächen lieferbar, abhängig von Modifikation und Stückzahl. /

Aliseo's accessories offer a visual stability and luxurious balance that complement the many different looks in bathroom décor: the contemporary NOW, the more defined Architecto, the timeless Tecno, and the unique NEXXUS.

\* Different finishes and treatments available depending on finish selection and quantity.



NU-Oberflächen bieten eine nahezu unbegrenzte Auswahl an Farben – gebürstet oder poliert – und sind mit praktisch jeder zur Verfügung gestellten Oberflächenbehandlung kompatibel / NU finishes are available in an almost endless choice of colors – matt, brushed or polished – and are compatible with virtually any provided designated finish

Sofern nicht anders angegeben, sind ALISEO Hotelbad-Accessoires aus Messing hergestellt. Alle Messing-Produkte mit verchromter Oberfläche unterliegen einer 10-jährigen Garantie, vorausgesetzt, dass sie richtig installiert wurden und die Pflegeanleitung befolgt wird.

PVD-Oberflächen unterliegen einer 5-jährigen Garantie, die NEXXUS-Linie, die eine pulverbeschichtete Oberfläche hat, unterliegt einer 2-jährigen Garantie. /

Unless otherwise stated all ALISEO accessories are manufactured from brass. All brass constructed items with chrome finish are warranted for 10 years providing proper installation and maintenance instructions are followed.

PVD surfaces are covered by a 5-year warranty, the NEXXUS line which has a powdered coated finish is warranted for 2 years.



Architecto

Tecno

NOW

ALISEO BATHSTYLES

NEXXUS

Hocker / Stools

Complementary

Abfallbehälter / Waste bins

Waagen / Scales



## Something for Everyone

NU-Oberflächen sind in einer nahezu unbegrenzten Auswahl an Farben und Oberflächen erhältlich, die mit dem Metallmuster des gewünschten Armaturenherstellers übereinstimmen. Die Farbkordinaten werden über ein 3-dimensionales Farbfotometer extrahiert. Die Werte werden nun berechnet, der Spiegel in eine Kammer gelegt und der PVD-Prozess beginnt. Die Farbanpassung ist mit jeder vorgesehenen Oberfläche kompatibel.

(Unten sehen Sie nur einen Querschnitt einiger unserer beliebtesten Oberflächen) /

NU colors are available in an almost endless variety of surface colors that conform to the metal swatch obtained from the desired faucet manufacturer.

Color coordinates are extracted via a 3 dimensional color photometer. The values are now calculated, the mirror placed in a chamber and the PVD process begins. Color match is compatible with any provided designated finish.

(Below is just a cross-section of some of our most popular finishes)

### POLIERT / POLISHED



CHROM 100 /  
CHROME 100



BRONZE 201



GOLDOPTIK 203 /  
GOLD OPTIC 203



MESSING 206 /  
BRASS 206



BRONZE 201



ROTGOLD 209 /  
RED GOLD 209



CHROM SCHWARZ 211 /  
BLACK CHROME 211

### GEBÜRSTET / BRUSHED



CHROM 302 /  
CHROME 302



BRONZE 301



GOLDOPTIK 303 /  
GOLD OPTIC 303



MESSING 306 /  
BRASS 306



BRONZE 301



ROTGOLD 309 /  
RED GOLD 309



CHROM SCHWARZ 311 /  
BLACK CHROME 311

Farbunterschiede aufgrund des Druckverfahrens vorbehalten.

Bitte gehen Sie auf unseren Konfigurator auf der NU-Finish Seite für eine operative Visualisierung. /

Subject to color differences due to the printing process.

Please go do our configurator NU finish page for an operational visualization.

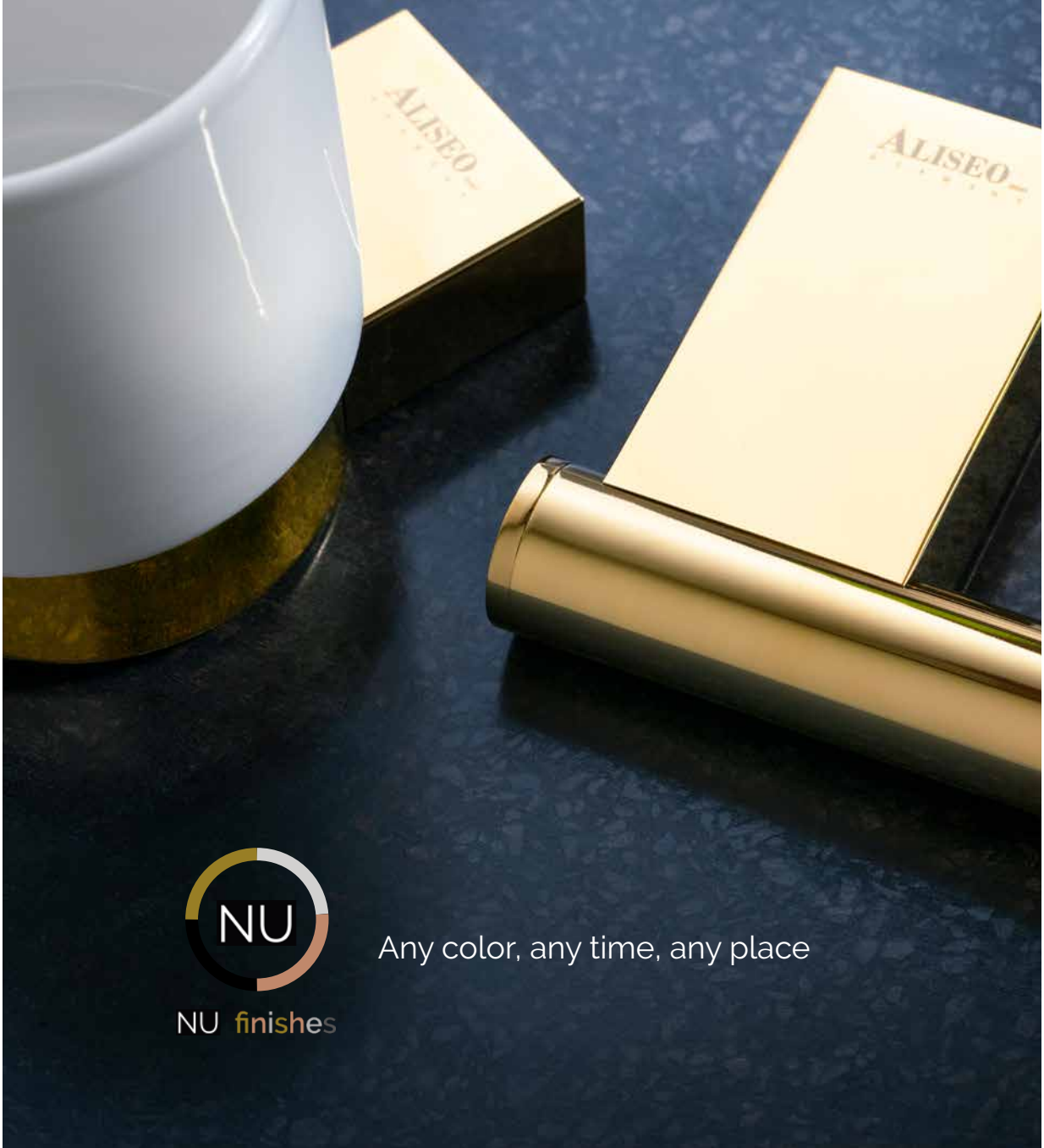

NU finishes

Any color, any time, any place

ARCHITECTO





**770018**  
Sicherheits-Haltegriff /  
Safety Grab Bar

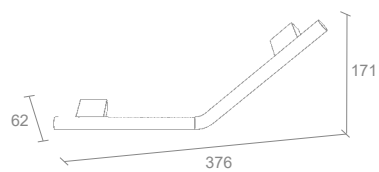





**770005**  
Haken /  
Hook

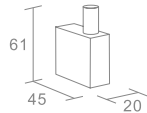

**770011**  
Seifenhalter  
Keramikschale /  
Soap Dish  
Ceramic Dish

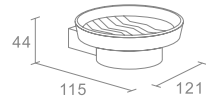

**770012**  
Seifenspender  
Keramik /  
Soap Dispenser  
Ceramic

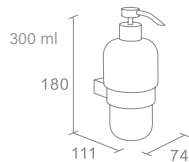

**770009**  
Becherhalter  
Keramikbecher /  
Tumbler Holder  
Ceramic Tumbler

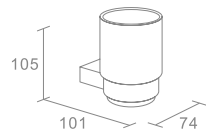

**770016**  
Handtuchhalter /  
Towel Rail

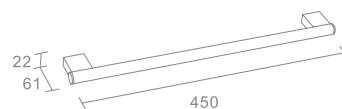



**770006**  
Papierrollenhalter /  
Toilet Roll Holder

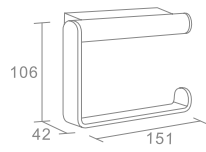

**770007**  
Reserverollenhalter /  
Spare Roll Holder

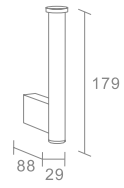

**770017**  
Papierrollenhalter /  
Toilet Roll Holder

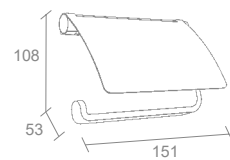

**770008**  
WC-Bürstengarnitur  
Keramikbehälter /  
Toilet Brush Holder  
Ceramic Case

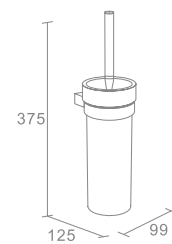





TECNO



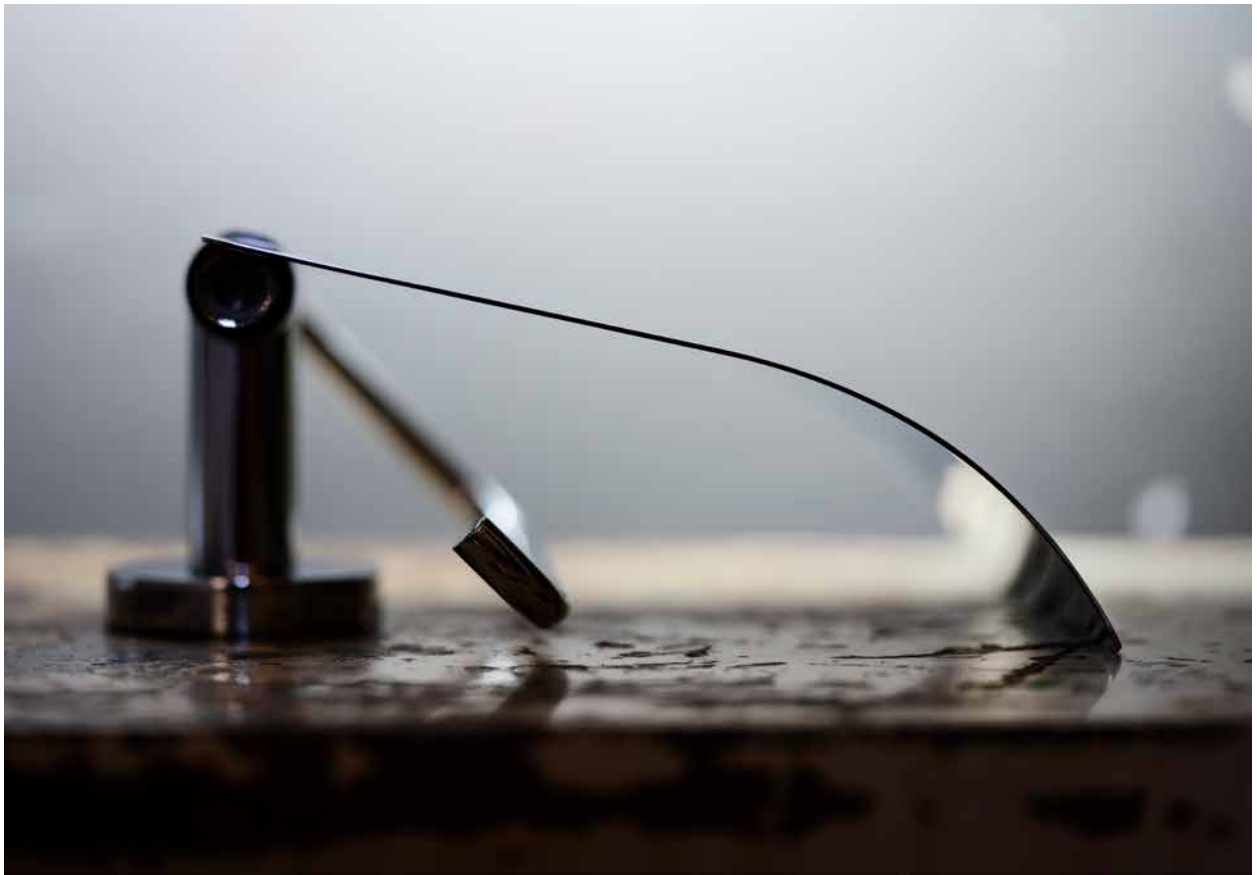

**710013**  
Papierrollenhalter /  
Toilet Roll Holder

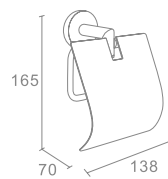



**710008**  
 Papierrollenhalter /  
 Toilet Roll Holder

**710061**  
 Ausführung links /  
 Left hand mount

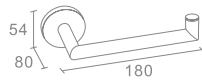

**710009**  
 Reserverollenhalter /  
 Spare Roll Holder

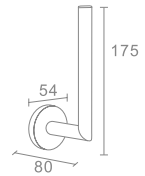

**710014**  
 Doppel-Haken /  
 Double Hook

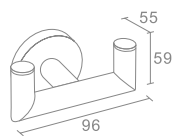

**710006**  
 Haken /  
 Hook

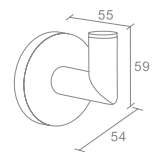

WC-Bürstengarnitur /  
Toilet Brush Holder

**030633**  
Standmodell /  
freestanding

**030707**  
Wandmontage /  
Wall mounted

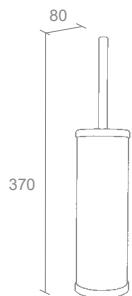





**710010**  
 WC-Bürstengarnitur  
 Satiniertes Glas /  
 Toilet Brush Holder  
 Iced Glass

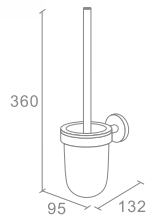



Sicherheits-Haltegriff /  
Safety Grab Bar

710053/ 710054

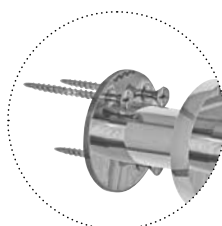
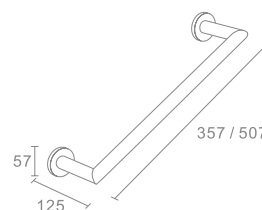

**FORMVOLLENDETE STÄRKE,  
SICHERHEIT UND STABILITÄT**

- 3-Punkt-Befestigung
- Zugbelastung bis zu 190 kg  
je nach Wandbauart /

**STYLISH STRENGTH, SAFETY  
AND STABILITY**

- Positive 3 point fixation system
- Up to 190 kilo pull-weight capacity  
depending on wall construction

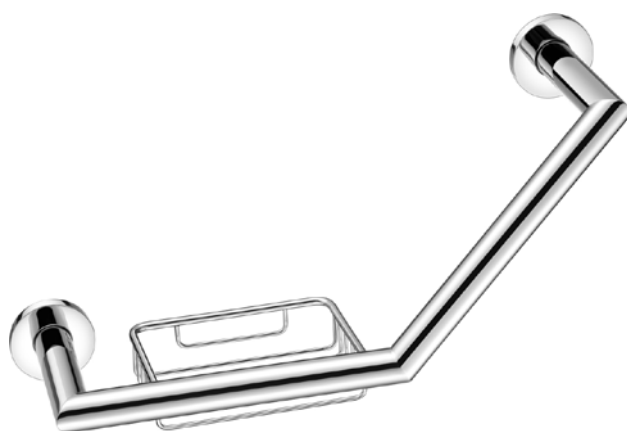

**710056**

Sicherheits-Haltegriff mit Seifenkörbchen  
Wechselseitige Montage /

Safety Grab Bar with Soap Basket  
Adjusts to left and right hand installations

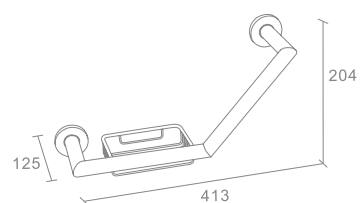



**710059**  
Handtuchablage /  
Towel Rack

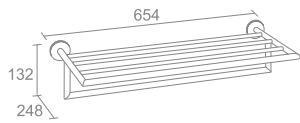

Handtuchhalter /  
Towel Rail

**710003/ 710052**

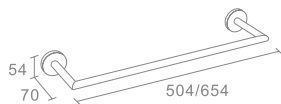

N O W





**740006**  
 Papierrollenhalter /  
 Toilet Roll Holder

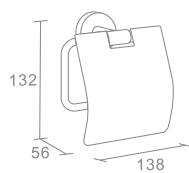

**740007**  
 Papierrollenhalter /  
 Toilet Roll Holder

**740066**  
 Ausführung links /  
 Left hand mount

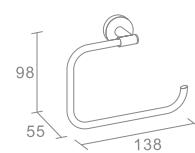



**740017**  
Reserverollenhalter /  
Spare Roll Holder

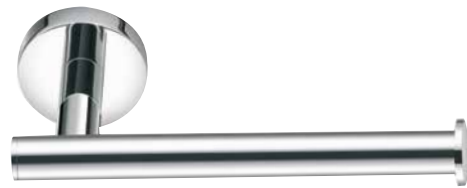
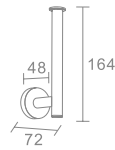

**740008**  
Papierrollenhalter /  
Toilet Roll Holder

**740065**  
Ausführung links /  
Left hand mount

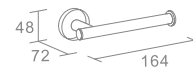

**740009**  
WC-Bürstengarnitur  
Satinieretes Glas /  
Toilet Brush Holder  
Iced Glass

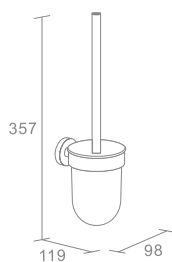

**740018**  
WC-Bürstengarnitur. Standmodell  
Edelstahl verchromt /  
Toilet Brush Holder. Free standing  
Stainless steel, chrome finish

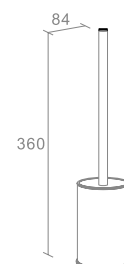

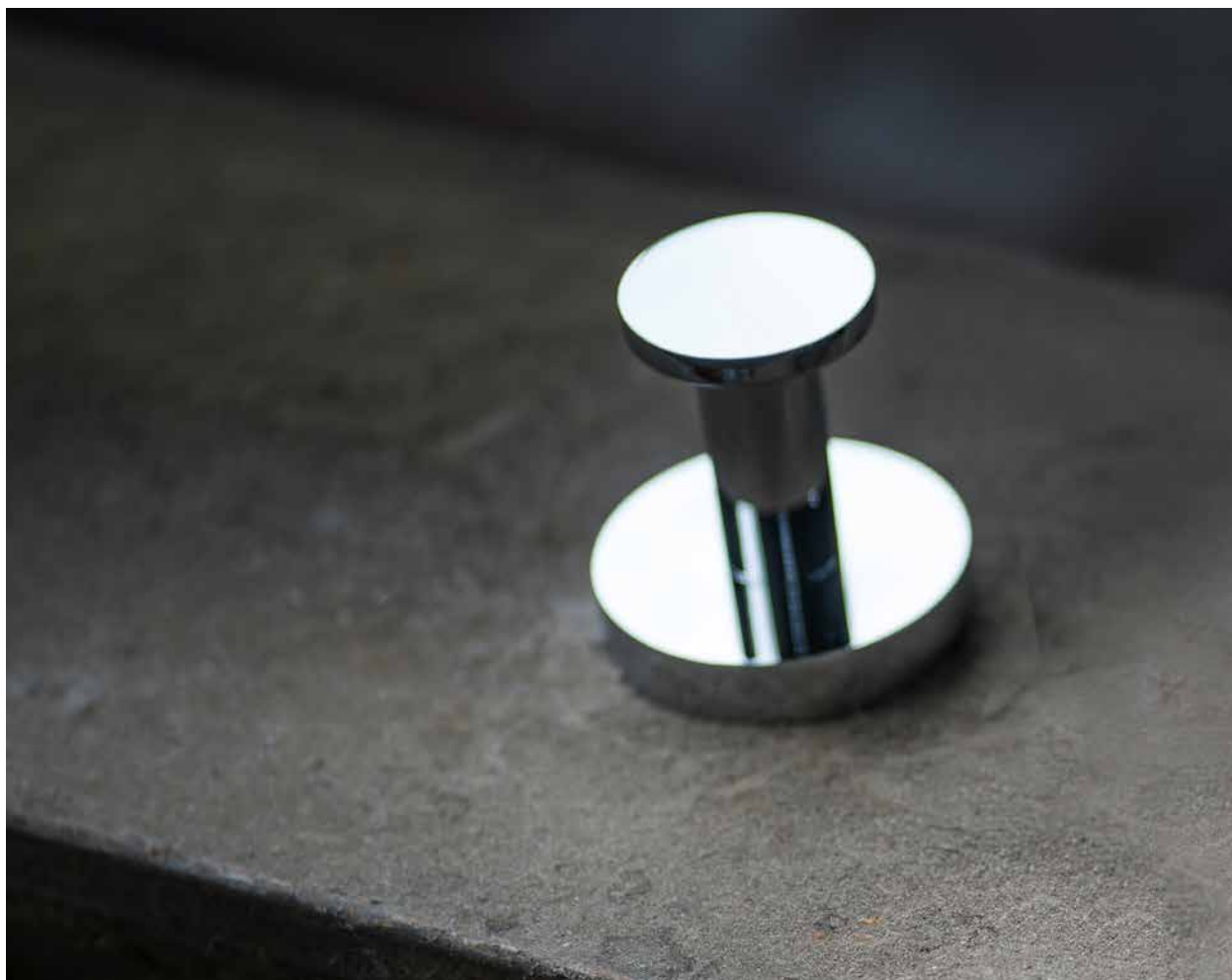

**740004**  
Doppel-Haken /  
Double Hook

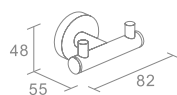

**740016**  
Haken /  
Hook

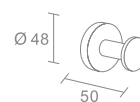





**740010**  
 Glashalter  
 Satiniertes Glas /  
 Glass Holder  
 Iced Glass

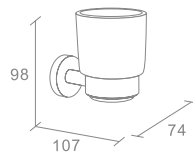

**030615**  
 Seifenspender MOON  
 Satiniertes Glas /  
 Soap Dispenser MOON  
 Iced Glass

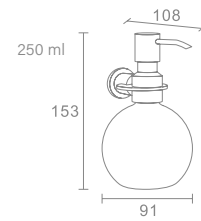

*\*Nicht für Duschanwendungen /  
 \*Not for shower applications*

**740001**  
 Handtuchablage /  
 Towel Rack

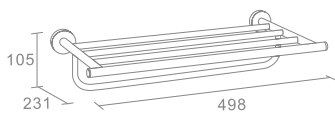

Handtuchhalter /  
 Towel Rail

**740002**

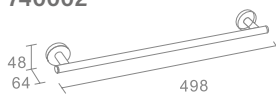

**740013**



NEXXUS





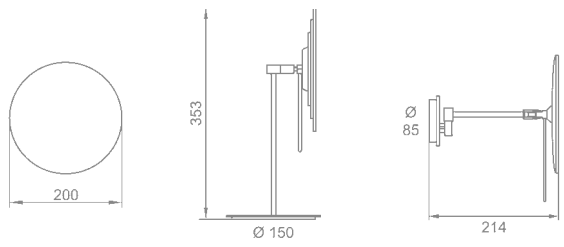

**COSMO MINIMALIST**

**020805** Standmodell / Free standing  
**020804** Schwenkarm / Single arm  
 3-fach-Vergrößerung / 3x magnification



**740053**  
 Seifenhalter  
 Satiniertes Glas /  
 Soap Dish  
 Iced Glass

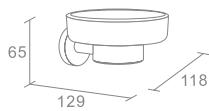

**740052**  
 Glashalter  
 Satiniertes Glas /  
 Glass Holder  
 Iced Glass

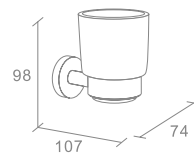

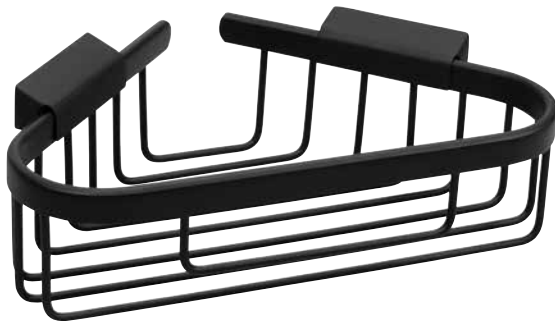

**030706**

Eckseifenkörbchen /  
Corner Soap basket

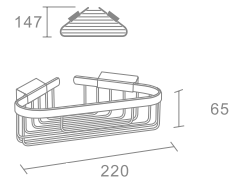

**740050**  
Doppel-Haken /  
Double Hook



**740045**  
Haken /  
Hook

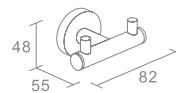



**020801**  
**LED CITY LIGHT**  
 SMD-LED-Beleuchtung  
 3-fach-Vergrößerung  
 Doppel-Schwenkarm /  
 SMD-LED-lighting  
 3x magnification  
 Twin Arm

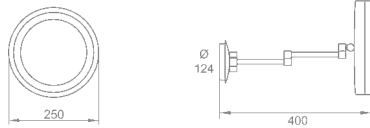

**020802**  
**CONCIERGE**  
 Plan- und 3-fach-Vergrößerung  
 Doppel-Schwenkarm /  
 Plain and 3x magnification  
 Twin arm

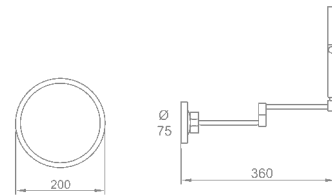

**740047/ 740054**

Handtuchhalter /  
 Towel Rail





**740038**  
Papierrollenhalter /  
Toilet Roll Holder

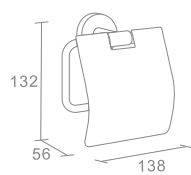

**740042**  
Papierrollenhalter /  
Toilet Roll Holder

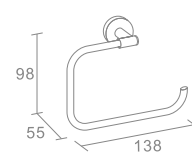



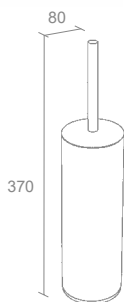

**030708**  
WC-Bürstengarnitur  
Wandmontage /  
Toilet Brush Holder  
Wall Mounted

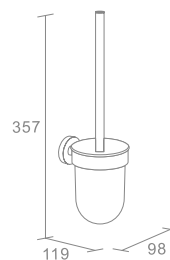

**740044**  
WC-Bürstengarnitur  
Satinieretes Glas /  
Toilet Brush Holder  
Iced Glass



**740046**  
Reserverollenhalter /  
Spare Roll Holder

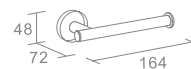

**740043**  
Papierrollenhalter /  
Toilet Roll Holder



**030662**

Hygienebaghalter  
Kunststoff /  
Sanitary Bag Dispenser  
Plastic

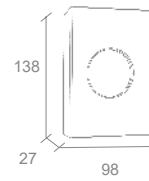

**030661**

Kosmetiktuchspender  
Kunststoff /  
Tissue Dispenser  
Plastic

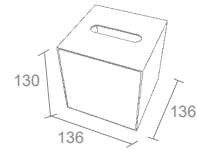

**190052**

LONDONER NOIR  
Kosmetiktuchspender.  
mit magnetischer Bodenklappe  
Kunstleder /  
Tissue Dispenser  
with magnetic trap at the bottom  
Faux leather

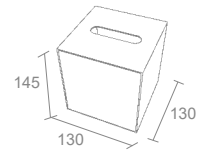

**030710**

Einbau- Kosmetiktuchspender  
Einbaumaße: 264 x 130 x 76 mm  
Messing /  
Built-in Tissue Dispenser  
Built-in dimensions: 264 x 130 x 76 mm  
Brass

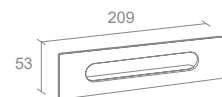

**190078**

LONDONER NOIR  
Kosmetiktuchspender.  
mit magnetischer Bodenklappe  
Kunstleder /  
Tissue Dispenser.  
with magnetic trap at the bottom  
Faux leather

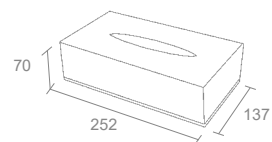



**PRESTIGE**  
 Hygieneeimer  
 Herausnehmbarer  
 Kunststoffeinsatz  
 Edelstahl. Schwarz /  
 Step Bin  
 Removable plastic  
 inner bin  
 Stainless steel. Black

**030692**  
 3 L

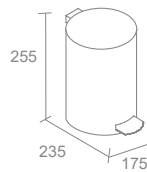

**030691**  
 5 L

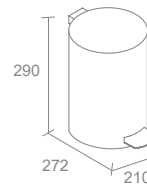

**190094**  
**LONDONER NOIR**  
 Abfallbehälter, 10 L  
 Kunstleder /  
 Waste Bin , 10 L  
 Faux leather

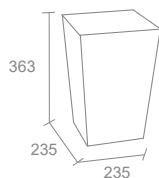

**190055**  
**LONDONER NOIR**  
 Abfallbehälter, 9 L  
 Kunstleder /  
 Waste Bin, 9 L  
 Faux leather

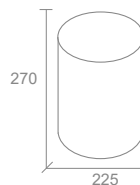

**030627**  
 Abfallbehälter - 13 L  
 Feuerfest. Abnehmbarer Deckel  
 Metall /  
 Waste Bin - 13 L  
 Fire-proof. Removable top  
 Metal

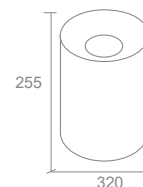

○ 115  
 Deckelöffnung /  
 Opening in the top

MAXIMA





## MAXIMA

Ein starkes, modernes Design, das maximale Stärke und funktionelle Schönheit vereint.  
Verdeckte Schrauben. Material: Zamak mit Pulverbeschichtung /

A bold contemporary design that combines maximum strength and utilitarian beauty.  
Covered screws. Material: Zamak with powder coating

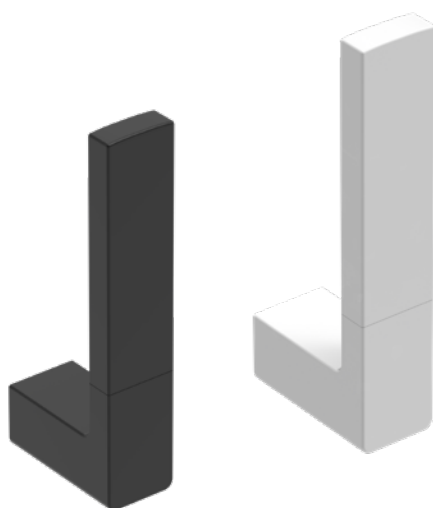

**793004** - schwarz / black matt  
**794004** - weiß / white matt

Reserverollenhalter /  
Spare Roll Holder

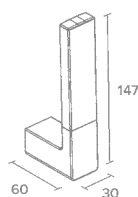

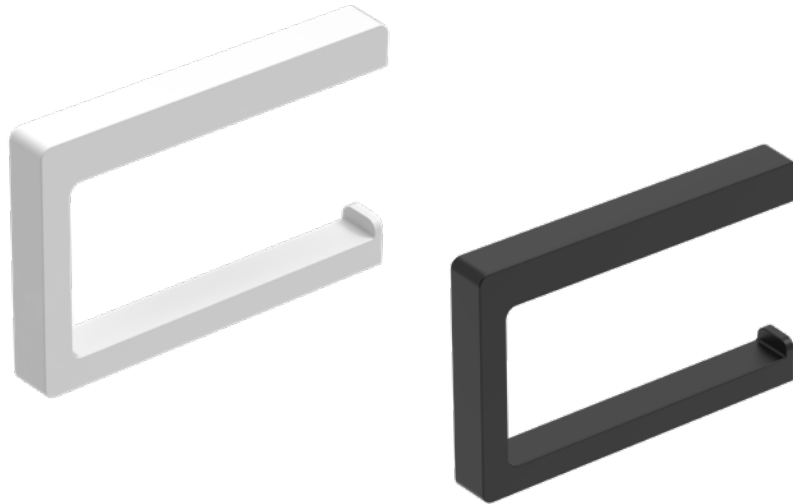

**793003** - schwarz / black matt  
**794003** - weiß / white matt  
Papierrollenhalter /  
Toilet Roll Holder

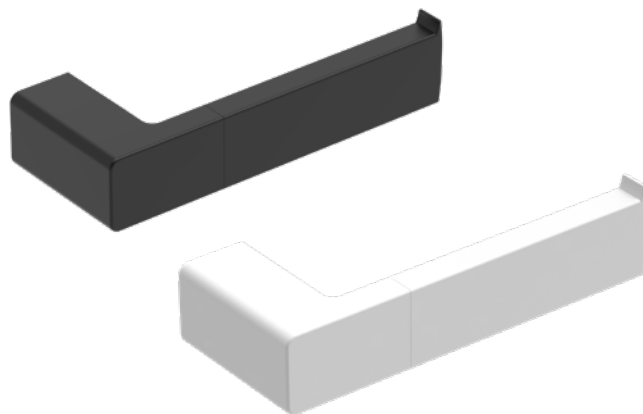
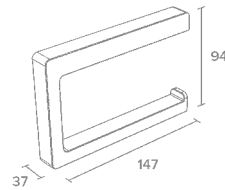

**793002** -- schwarz / black matt  
**794002** - weiß / white matt  
Papierrollenhalter /  
Toilet Roll Holder

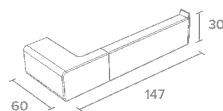



MAXIMA

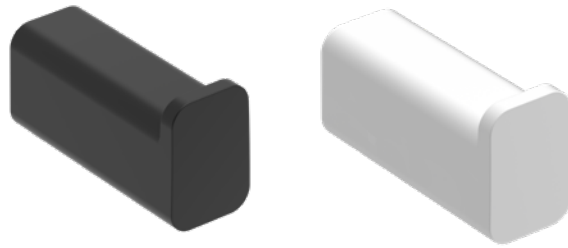

**793001** - schwarz / black matt  
**794001** - weiß / white matt

Haken /  
Hook

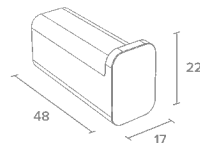

**030672** - schwarz / black matt  
**030674** - weiß / white matt

WC-Bürstengarnitur  
Wandmontage oder Standmodell  
Herausnehmbarer Kunststoffeinsatz /  
Toilet Brush Holder  
Wall mounted or free standing model  
Removable plastic insert

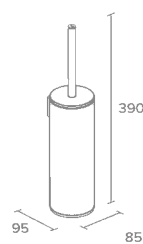



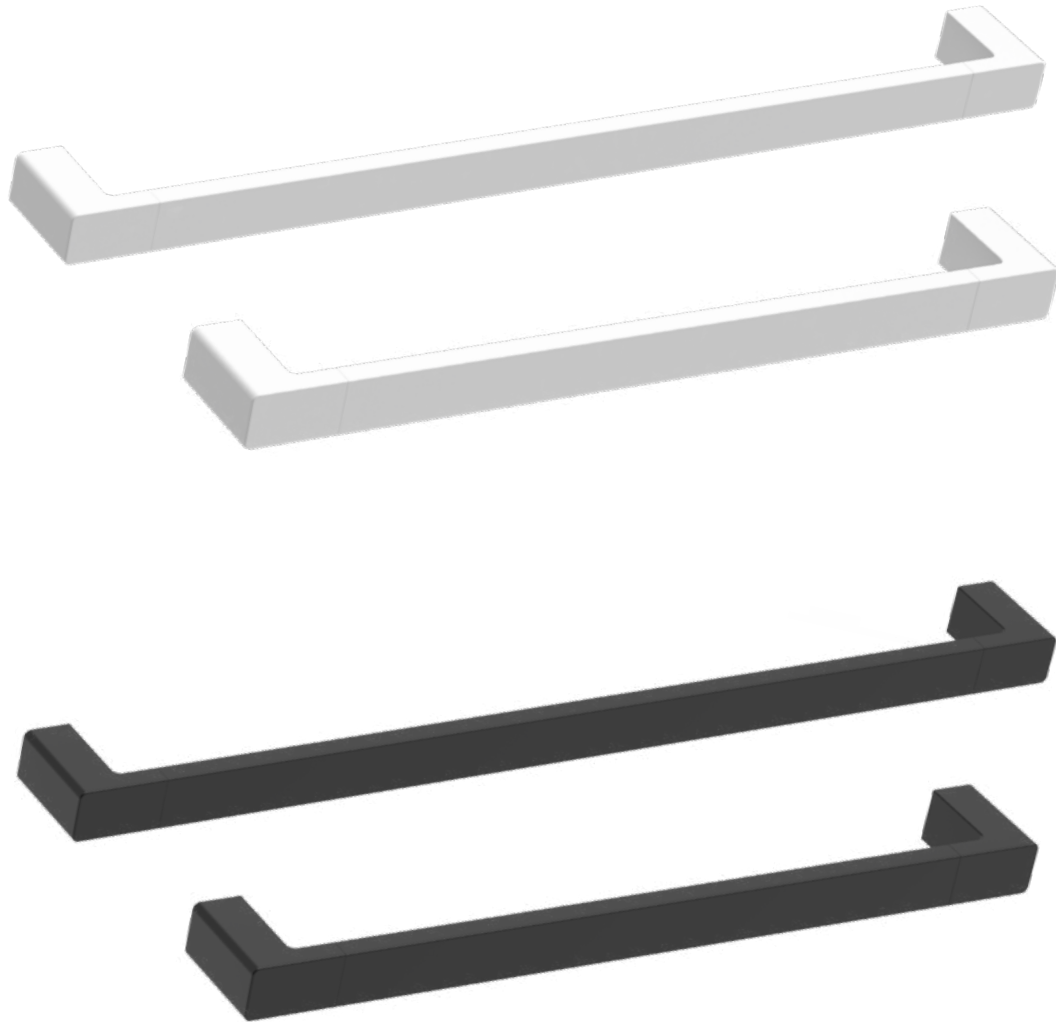

**793005** - schwarz / black matt  
**794005** - weiß / white matt

Handtuchhalter /  
 Towel Rail

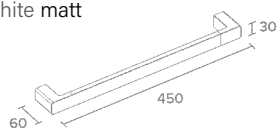

**793006** - schwarz / black matt  
**794006** - weiß / white matt

Handtuchhalter /  
 Towel Rail

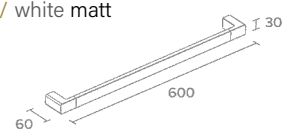



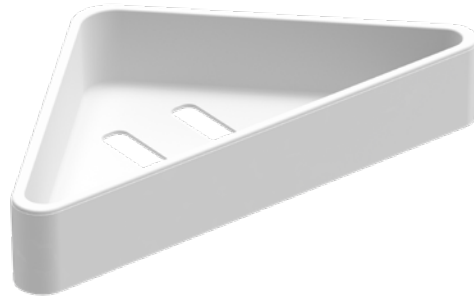
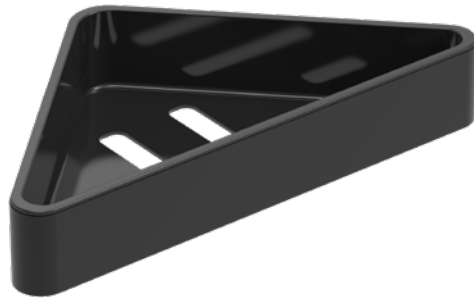

033677 - schwarz / black  
034677 - weiß / white

Seifenkörbchen  
Edelstahl mit matter  
Pulverbeschichtung  
Herausnehmbarer ABS-  
Kunststoffeinsatz /  
Corner Soap basket  
Stainless steel with  
matt powder coating  
Removable, ABS plastic insert

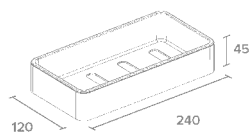

033671 - schwarz / black  
034671 - weiß / white

Eckseifenkörbchen  
Edelstahl mit matter  
Pulverbeschichtung  
Herausnehmbarer ABS-  
Kunststoffeinsatz /  
Corner Soap basket  
Stainless steel with  
matt powder coating  
Removable, ABS plastic insert

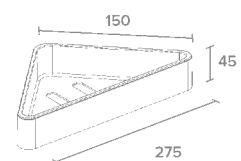



# ARCHITECTO



770016

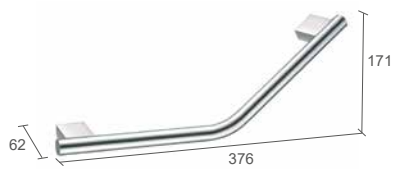

770018

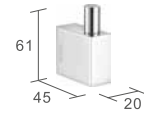

770005



770009



770012

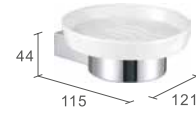

770011

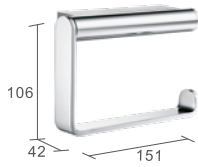

770006

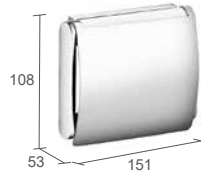

770017

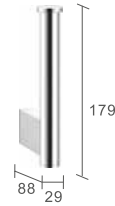

770007



770008



# MAXIMA

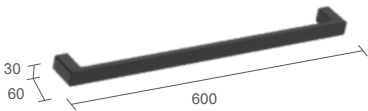

793006 - schwarz / black matt  
794006 - weiß / white matt



793005 - schwarz / black matt  
794005 - weiß / white matt

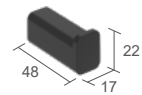

793001 - schwarz / black matt  
794001 - weiß / white matt

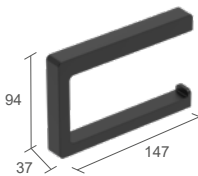

793003 - schwarz / black matt  
794003 - weiß / white matt

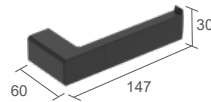

793002 - schwarz / black matt  
794002 - weiß / white matt

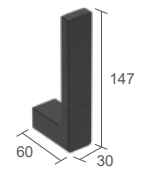

793004 - schwarz / black matt  
794004 - weiß / white matt

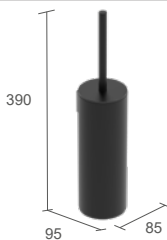

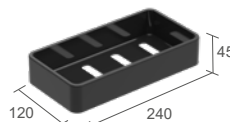

030672 - schwarz / black matt  
030674 - weiß / white matt

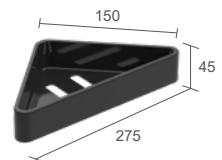

033677 - schwarz / black matt  
034677 - weiß / white matt

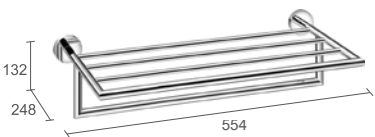
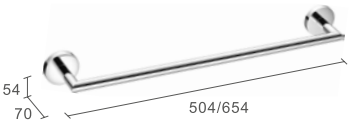
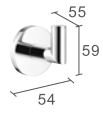
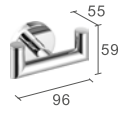
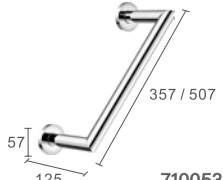
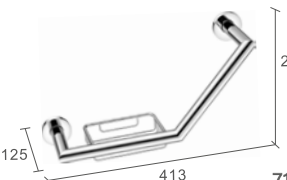
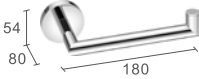
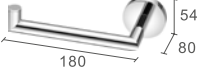
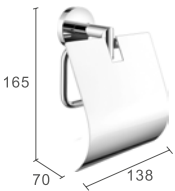
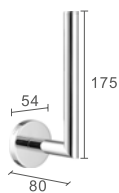

033671 - schwarz / black matt  
034671 - weiß / white matt

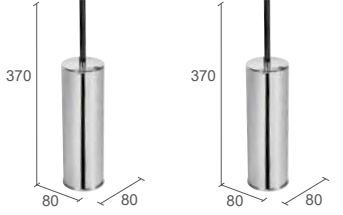
 <p>132 248 554</p> <p><b>710059</b></p>	 <p>54 70 504/654</p> <p><b>710003 710052</b></p>	 <p>55 59 54</p> <p><b>710006</b></p>
 <p>55 59 96</p> <p><b>710014</b></p>	 <p>357 / 507 57 125</p> <p><b>710053 710054</b></p>	 <p>204 125 413</p> <p><b>710056</b></p>
 <p>54 80 180</p> <p><b>710008</b></p>	 <p>54 80 180</p> <p><b>710061</b></p>	 <p>165 70 138</p> <p><b>710013</b></p>
 <p>175 54 80</p> <p><b>710009</b></p>	 <p>360 132 95</p> <p><b>710010</b></p>	 <p>370 80 80</p> <p>Free standing Freistehend <b>030633</b></p> <p>370 80 80</p> <p>Wall mounted Wandmontage <b>030707</b></p>



NOW

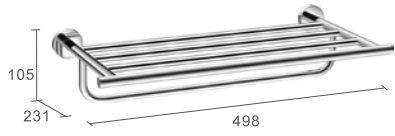

740001



740002 740013



030615

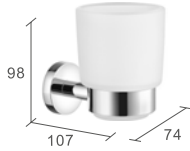

740010

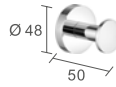

740016

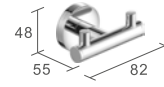

740004

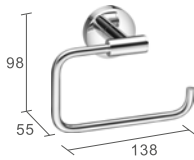

740007

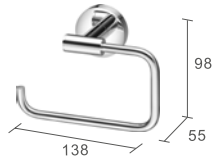

740066

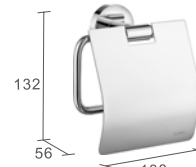

740006

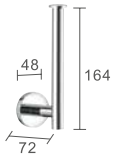

740017

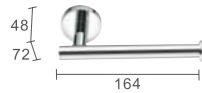

740008

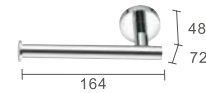











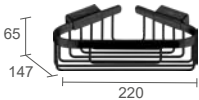

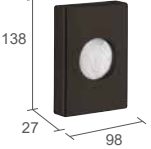
740065

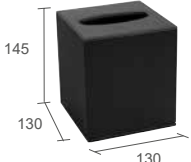
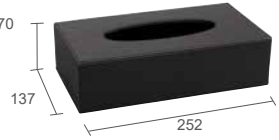
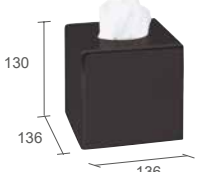

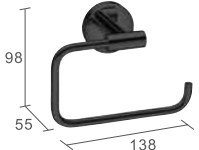
740009



740018

 <p>740047 740054</p>	 <p>740050 740045</p>	 <p>030706</p>
 <p>740053</p>	 <p>740052</p>	 <p>030662</p>
 <p>030710</p>	 <p>190052</p>	 <p>190078</p>
 <p>030661</p>	 <p>740038</p>	 <p>740042</p>
 <p>740043</p>	 <p>740046</p>	 <p>030708</p>
<p>740044</p>	 <p>030691 030692</p>	 <p>030627</p>

COMPLEMENTARY







**740050**  
 Doppel-Haken. Schwarz  
 Messing mit  
 Pulverbeschichtung /  
 Double Hook. Black  
 Brass with powder coating

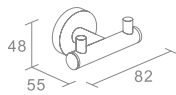

**740045**  
 Haken. Schwarz  
 Messing mit  
 Pulverbeschichtung /  
 Hook. Black  
 Brass with powder coating



**030706**  
 Eckseifenkörbchen  
 Messing mit  
 Pulverbeschichtung /  
 Corner Soap basket  
 Brass with powder coating

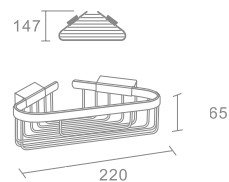



**770005**

Haken  
Messing, verchromt /  
Hook  
Brass, chrome finish

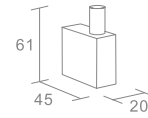

**710006**

Haken  
Messing, verchromt /  
Hook  
Brass, chrome finish

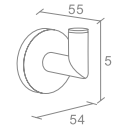

**740016**

Haken  
Messing, verchromt /  
Hook  
Brass, chrome finish

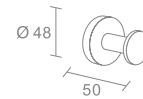

**030527**

Haken  
Messing, verchromt /  
Hook  
Brass, chrome finish



**740004**

Doppel-Haken  
Messing, verchromt /  
Double Hook  
Brass, chrome finish

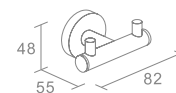

**710014**

Doppel-Haken  
Messing, verchromt /  
Double Hook  
Brass, chrome finish

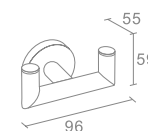



# SOAP BASKETS

... mit spezieller Schraubenabdeckung  
... with covered screws



**030461/ 030466**

Eckseifenkörbchen  
Messing, verchromt /  
Corner Soap Basket  
Brass, chrome finish

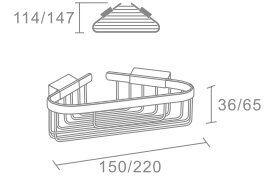

**030509**  
Eckseifenkörbchen  
Messing, verchromt /  
Corner Soap Basket  
Brass, chrome finish

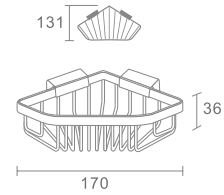

**030462**  
Eckseifenkörbchen  
Messing, verchromt /  
Corner Soap Basket  
Brass, chrome finish

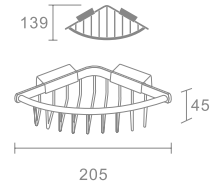

**030533**  
Eck-Ablage  
Messing, verchromt /  
Corner Shelf  
Brass, chrome finish

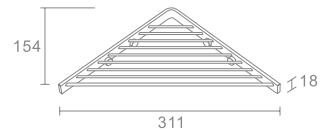

**030464**  
Seifenkörbchen  
Messing, verchromt /  
Soap Basket  
Brass, chrome finish

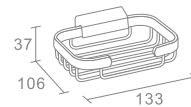

**030463**  
Seifenkörbchen  
Messing, verchromt /  
Soap Basket  
Brass, chrome finish

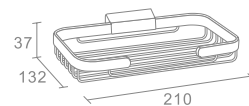

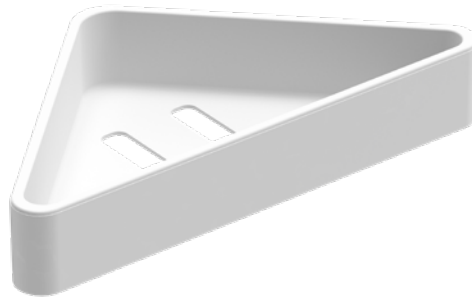
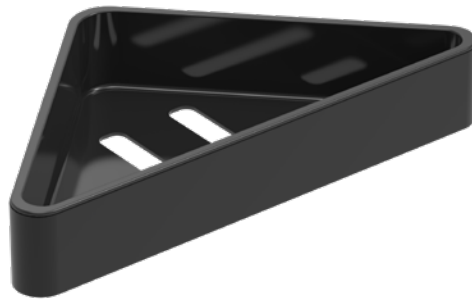

weiß / white



schwarz / black

033677 - schwarz / black  
034677 - weiß / white

Seifenkörbchen  
Edelstahl mit matter  
Pulverbeschichtung  
Herausnehmbarer ABS-  
Kunststoffeinsatz /  
Corner Soap basket  
Stainless steel with  
Matt powder coating  
Removable, ABS plastic insert

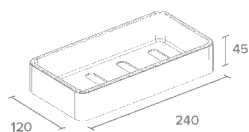

033671 - schwarz / black  
034671 - weiß / white

Eckseifenkörbchen  
Edelstahl mit matter  
Pulverbeschichtung  
Herausnehmbarer ABS-  
Kunststoffeinsatz /  
Corner Soap basket  
Stainless steel with  
matt powder coating  
Removable, ABS plastic insert

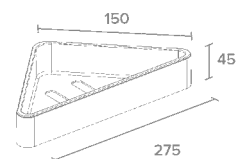



# HALTEGRIFFE/ GRAB BARS



Sicherheits-Haltegriff /  
Safety Grab Bar

710053/ 710054

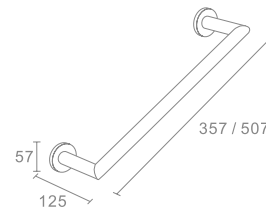

770018

Sicherheits-Haltegriff /  
Safety Grab Bar

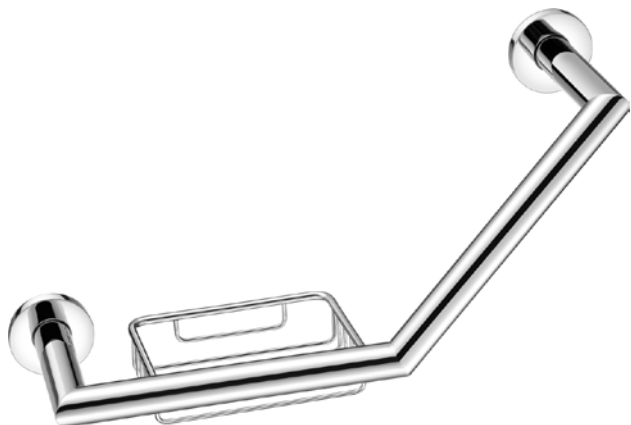
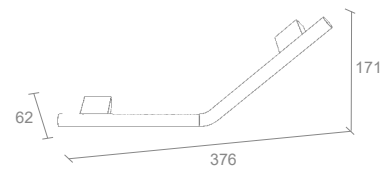

710056

Sicherheits-Haltegriff mit Seifenkörbchen  
Wechselseitige Montage /  
Safety Grab Bar with Soap Basket  
Adjusts to left and right hand installations

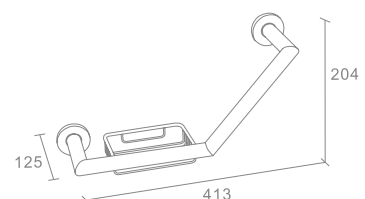







**030618**  
Handtuchring /  
Towel Ring

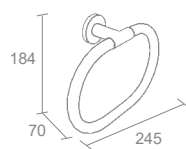





**030615**

Seifenspender MOON  
 Satiniertes Glas. Messing, verchromt /  
 Soap Dispenser MOON  
 Iced glass. Brass, chrome finish

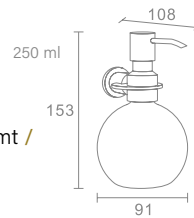

**030614**

Seifenspender CARLTON  
 Satiniertes Glas. Messing, verchromt /  
 Soap Dispenser CARLTON  
 Iced glass. Brass, chrome finish

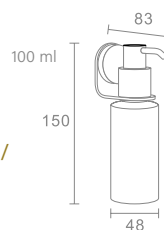



**030416**

Wäscheleine  
 Messing, verchromt /  
 Clothes Line  
 Brass, chrome finish

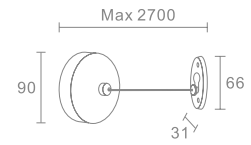

**030494**

Wäscheleine  
 Messing, verchromt /  
 Clothes Line  
 Brass, chrome finish

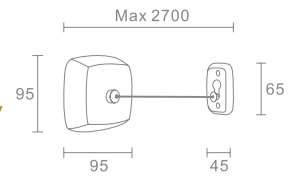

**740018**

WC-Bürstengarnitur. Standmodell  
 Edelstahl verchromt /  
 Toilet Brush Holder. Free standing  
 Stainless steel, chrome finish

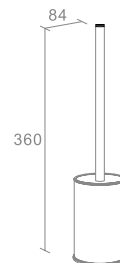



**030506**

Kosmetiktuchspender CUBE  
Kunststoff, verchromt /  
Tissue Dispenser CUBE  
Plastic, chrome finish

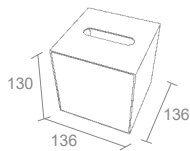

**030724**

Kosmetiktuchspender  
ABS-Kunststoff, verchromt /  
Tissue Dispenser  
ABS-plastic, chrome finish

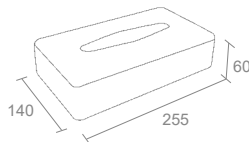

**030628**

Hygienebaghalter  
Kunststoff, verchromt /  
Sanitary Bag Dispenser  
Plastic, chrome finish

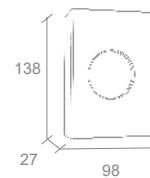

**030449**

Einbau- Kosmetiktuchspender  
Einbaumaße: 264 x 130 x 76 mm  
Messing, verchromt /  
Built-in Tissue Dispenser  
Built-in dimensions: 264 x 130 x 76 mm  
Brass, chrome finish

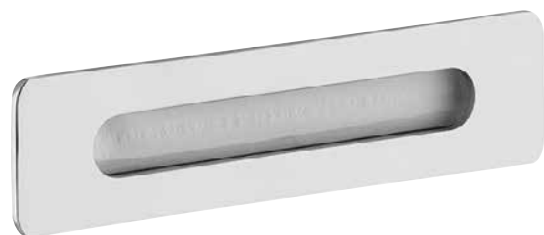
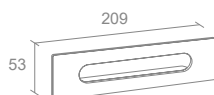

HAVE A SEAT

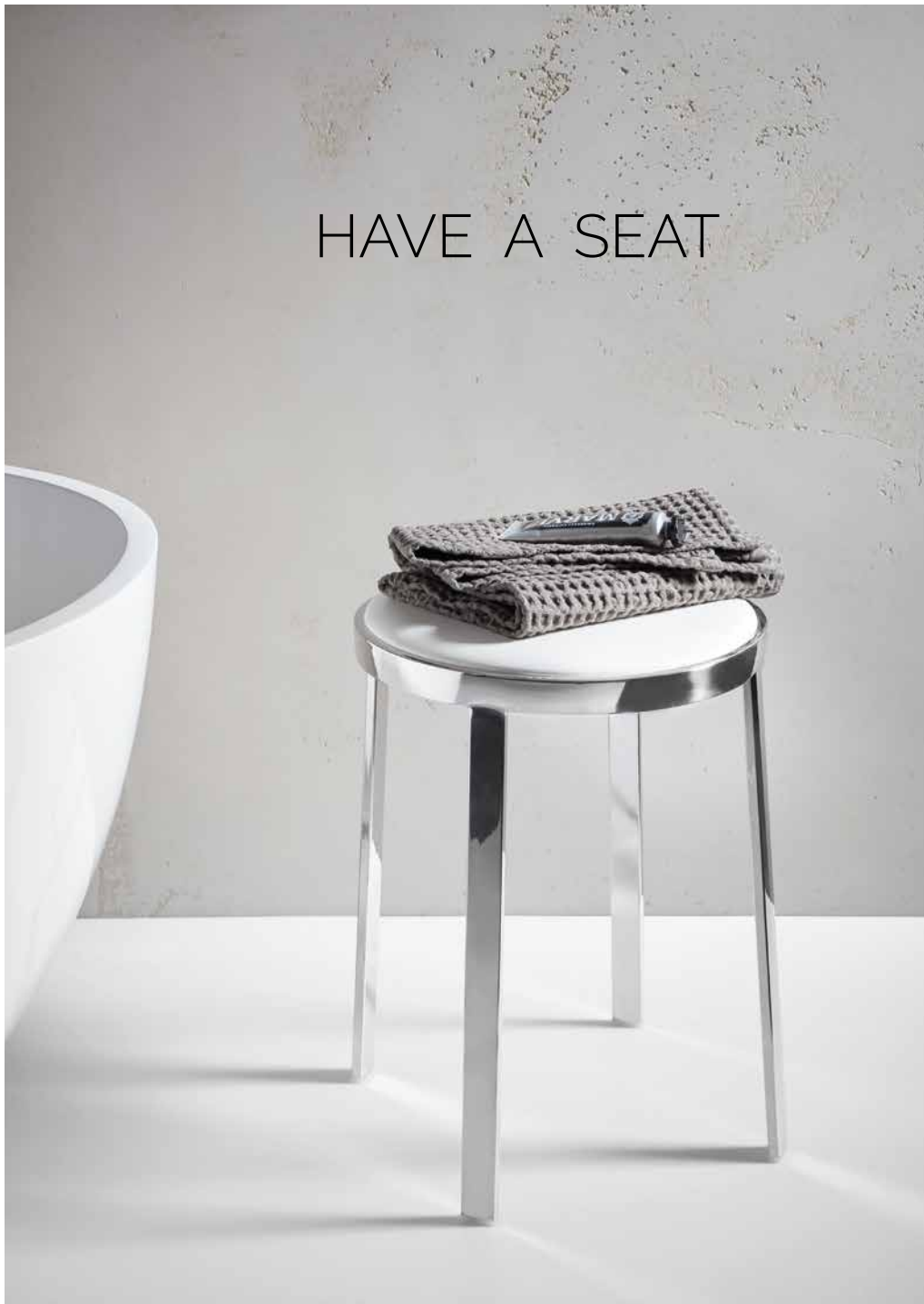

**030483**

Badezimmerhocker ANTIGUA

Sitz: PVC, weiß, gepolstert / Gestell: Metall, verchromt /

Bathroom Stool ANTIGUA

Seat: PVC, white, padded / Legs: Metal, chrome finish

**030089**

Badezimmerhocker PURI

Sitz: ABS-Kunststoff, weiß / Gestell: Metall, verchromt /

Bathroom Stool PURI

Seat: ABS-plastic, white / Legs: Metal, chrome finish

**030485**

Badezimmerhocker ZANZIBAR

Sitz: PVC, weiß, gepolstert / Gestell: Metall, verchromt /

Bathroom Stool ZANZIBAR

Seat: PVC, white, padded / Legs: Metal, chrome finish



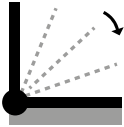

#### ABSENK-AUTOMATIK & STABILES PEDALSYSTEM

Ein patentiertes Hydrauliksystem ermöglicht das geräuscharme Absenken des Deckels. Das verstärkte Pedal verteilt die Kraft gleichmäßig. Ein solides System, das über 100.000 Betätigungen ermöglicht. /

#### SILENT SOFT CLOSE SYSTEM

Intelligent soft-close function controlled by a patented hydraulic lid system. Rib-reinforced steel pedal distributes foot force equally. Extending service life in upwards of 100,000 steps.



#### ANTI-FINGERABDRUCK

Hochwertiger Edelstahl mit spezieller Anti-Fingerabdruck-Lackierung. Die Oberfläche bleibt frei von Abdrücken und ist einfacher zu reinigen. /

#### FINGERPRINT RESISTANT

High-quality stainless steel with fingerprint resistant coating keeps the bin clean and easy to maintain.

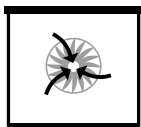

#### BEUTELFIXIERUNG

Plastikbeutel lassen sich mittels einer Befestigungsöse am Inneneimer problemlos befestigen. /

#### PLASTIC BAG FIXER

Plastic bag fixer helps secure the bag with no visible excess, keeping the bags neat and orderly.



#### SICHERER STAND

Kunststoffboden mit rutschfesten, oberflächen-schonenden Pads geben dem Eimer Stabilität.

#### SOLID BASE

Plastic bottom, non-skid base and insulated pads are gentle on the floor and keeps the bin steady.





# WASTE NOT

## Manage your waste

In Aliseo's moderner und herausragender Handwerkskunst spiegeln sich technische Innovationen wider, die gleichzeitig durch Ihren hohen Nutzen und die leichte Handhabung bestechen. /

Contemporary craftsmanship at its finest, Aliseo's sensible technology and intelligent solutions combine clarity of purpose with utilitarian beauty.

# PRESTIGE



## PRESTIGE

Hygieneeimer  
Herausnehmbarer Kunststoffeinsatz  
Edelstahl,

Step Bin  
Removable plastic inner bin  
Stainless steel



**030654**  
chrom, gebürstet /  
brushed chrome

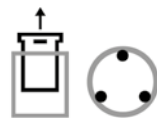

**030692**  
schwarz /  
black



**030655**  
chrom, gebürstet /  
brushed chrome

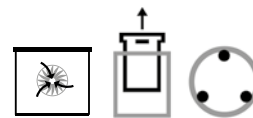

**030691**  
schwarz /  
black



THE  
CLASSIC



Herausnehmbarer, solider INNENEIMER  
Verstärktes Gelenk mit Tragegriff /  
Durable lift-out INNER BUCKET catches messy drips  
Strong back handle



# PRESTIGE



Ideal für Suiten, Apartments oder Ferienwohnungen.

EZ STAY Hygieneeimer für einen unbeschwerten Aufenthalt. /

Ideal for suite, apartment or extended stay applications.

The EZ STAY BIN makes your guest's stay easier.

LANGLEBIG

Extra breites Pedal verteilt die Kraft gleichmäßig. Ein solides Pedalsystem gewährleistet über 100.000 Betätigungen. /

DURABLE

Rib-reinforced extra large steel pedal distributes foot force equally, extending service life in upwards of 100,000 steps.



2-FACH INNENEIMER

Zwei separate Inneneimer für einfache Mülltrennung und Müllentsorgung. /

DOUBLE INNER BUCKETS

Double inner liners for easy separation and recycling.



STAY-OPEN-FUNKTION

Komfortable Deckelverankerung bei längerem Gebrauch. /

STAY OPEN DESIGN

Lid lock-out for convenient longer term usage.



030659

PRESTIGE EZ STAY

Hygieneeimer - 10 L + 9 L

Zwei herausnehmbare

Kunststoffeinsätze

Edelstahl, gebürstet /

Step Bin - 10 L + 9 L

Two removable plastic inner bins  
Stainless steel, brushed finish





**ABNEHMBARER RING INNENEIMER OHNE ABDECKUNG**

Offener Eimer für mühelose Abfallbeseitigung. Abnehmbarer Ring und Inneneimer mit Abfallbeutelbefixierung und Henkel ermöglichen eine saubere Entsorgung. /

**LIFT-OFF LID INNER BUCKET OPEN TOP**

Open mouth design for effortless trash discard. Lift-off lid and removable liner with waste bag fixer and sure-grip handle make for fast easy trash disposal.

**030660**

**PRESTIGE**

Abfallbehälter - 9 L

Herausnehmbarer

Kunststoffeinsatz

Edelstahl, gebürstet /

Waste Bin - 9 L

Removable plastic inner bin

Stainless steel, brushed finish





030657

PRESTIGE

Hygieneeimer - 5 L

Herausnehmbarer

Kunststoffeinsatz

Edelstahl, gebürstet /

Step Bin - 5 L

Removable plastic inner bin

Stainless steel, brushed finish





**030720**

**PRESTIGE**

Abfallbehälter - 3 x 3,5 L  
 3 herausnehmbare Kunststoffeinsätze  
 (schwarz, grün, blau)  
 Edelstahl, gebürstet /  
 Waste Bin - 3 x 3,5 L  
 3 removable plastic inner bins  
 (black, green, blue)  
 Stainless steel, brushed finish

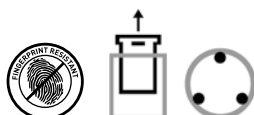

**030712**

**PRESTIGE**

Abfallbehälter - 2 x 5 L  
 2 herausnehmbare Kunststoffeinsätze  
 (schwarz, grün)  
 Edelstahl, gebürstet /  
 Waste Bin - 2 x 5 L  
 2 removable plastic inner bins  
 (black, green)  
 Stainless steel, brushed finish

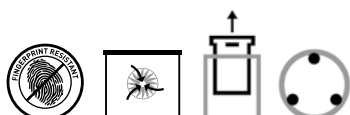

**030627**

Abfallbehälter- 13 L  
 Feuerfest. Abnehmbarer Deckel  
 Kunststoffbodenring  
 Metall. Schwarz-anthrazit /  
 Waste Bin - 13 L  
 Fire-proof. Removable top  
 Plastic ring at the bottom  
 Metal. Black-anthracite





**030490****BOHEMIA**

Mechanisch - Extra groß

Großzügige Trittfläche

Verzerrungsfreie Glasscheibe

Solide Konstruktion

Tragkraft max. 160 kg

Teilung 500 g

Anzeige in Kilo und Pfund

Material: Metall, korrosions-  
geschützte Emailbeschichtung /

Mechanical - Extra Large

Comfortable platform

Fog-free glass lens

Durable construction

Capacity max. 160 kg

Graduation 500 g

Display kg and lbs

Material: metal / corrosion  
resistant enamelled coating





### 030626

#### NEVIS

Elektronisch  
 6-mm-starkes Sicherheitsglas  
 Tragkraft max. 150 kg  
 Teilung 100 g  
 Umschaltbar auf Pfund (lbs)  
 Step-on-Funktion  
 4 Gewichtssensoren  
 Automatische Abschaltung  
 3 x 1,5V-AAA-Batterien  
 Material Unterteil: ABS-Kunststoff /  
 Electronic  
 6 mm-thick safety glass  
 Capacity max. 150 kg  
 Graduation 100 g  
 Switchable to pounds (lbs)  
 Step-On technology  
 4 integrated sensors  
 Auto shut-off  
 3 x 1.5V-AAA batteries  
 Material underpart: ABS plastic

338  330 | 21/35



### 030475

#### FUTURA

Elektronisch  
 6-mm-starkes Sicherheitsglas  
 Tragkraft max. 200 kg  
 Teilung 100 g  
 Umschaltbar auf Pfund (lbs)  
 4 Gewichtssensoren  
 Automatische Abschaltung  
 Long-life Lithium Batterie  
 Material Unterteil: korrosionsgeschützte  
 Epoxid- Kunststoffbeschichtung /  
 Electronic  
 6 mm-thick safety glass  
 Capacity max. 200 kg  
 Graduation 100 g  
 Switchable to pounds (lbs)  
 4 integrated sensors  
 Auto shut-off  
 Long-life Lithium battery  
 Material underpart: Corrosion resistant  
 Epoxy-plastic coating

300  300 | 35



**030653****STEP**

Elektronisch  
 6-mm-starkes Sicherheitsglas  
 Tragkraft max. 150 kg  
 Teilung 100 g  
 Umschaltbar auf Pfund (lbs)  
 Step-on-Funktion  
 4 Gewichtssensoren  
 Automatische Abschaltung  
 1 x 3V Lithium Batterie  
 Material Rahmen und Unterteil:  
 ABS Kunststoff /  
 Electronic  
 6 mm-thick safety glass  
 Capacity max. 150 kg  
 Graduation 100 g  
 Switchable to pounds (lbs)  
 Step-on technology  
 4 integrated sensors  
 Auto shut-off  
 1 x 3V lithium battery  
 Material frame and underpart: ABS plastic

306  | 22

**030544****TEMPO**

Elektronisch  
 8-mm-starkes Sicherheitsglas  
 Tragkraft max. 180 kg  
 Teilung 100 g  
 Umschaltbar auf Pfund (lbs)  
 4 Gewichtssensoren  
 Automatische Abschaltung  
 80 x 40 mm Display-Anzeige mit  
 blauer Hintergrundbeleuchtung  
 4x AAA Batterien  
 Material Unterteil: ABS Kunststoff /  
 Electronic  
 8 mm-thick safety glass  
 Capacity max. 180 kg  
 Graduation 100 g  
 Switchable to pounds (lbs)  
 4 integrated sensors  
 Auto shut-off  
 80 x 40 mm LCD display  
 with blue backlight  
 4x AAA batteries  
 Material underpart: ABS plastic

330  | 28



**ALISEO** GmbH  
G E R M A N Y

Leutkirchstraße 63, 77723 Gengenbach, Germany  
Tel. +49 (0) 78 03-60 279-0  
Fax +49 (0) 78 03-60 279-30  
Internet: [www.aliseo.de](http://www.aliseo.de)  
E-Mail: [info@aliseo.de](mailto:info@aliseo.de)