



KOSMETIKSPIEGEL / COSMETIC MIRRORS

ALISEO_{GmbH}
G E R M A N Y



Ambiente Hintergrundbeleuchtung /
Backside ambient lighting

LED MOON DANCE



THE ULTIMATE IN COSMETIC CARE

Mit „Moon Dance by Aliseo“ hat sieger design eine neue Dimension geschaffen: Die „mondartige“ Aura des Spiegels entsteht durch den transluzenten Acrylkörper, der sein Licht auf subtile Weise, ganzheitlich und in alle Richtungen, entfaltet. Feinste Materialien, minutiöse Oberflächenverarbeitung und eine solide Konstruktion geben Robustheit und Langlebigkeit.

Das lichtdurchlässige Gehäuse aus Acryl sorgt für unverwechselbare ambiente Hintergrundbeleuchtung. Elegante runde Formen, eine weiche Rückenkrümmung sowie eine fein strukturierte Oberfläche simulieren den nächtlichen Himmelskörper./

Developed exclusively for Aliseo by sieger design, the Moon Dance features clean defined lines, new materials and lighting methodologies creating an understated sculptural form of individualized taste and technological seduction. Translucent acrylic housing creates a distinctive backside ambient light.

Circular motif, soft dorsal curvature and smooth textured finish simulate the nocturnal celestial body.

LED MOON DANCE

SMD-LED-Beleuchtung
Warmweißes Licht, 3500-4000 K
Kühles weißes Licht, 5000-5500 K
3-fach-Vergrößerung
High-Tech-Tastschalter
Transluzenter Acryl-Rahmen
Kugelgelenk
Schutzklasse I
100-240 V
Direktanschluss
Messingkonstruktion

SMD-LED-lighting
Warm white light, 3500-4000 K
Cool white light, 5000-5500 K
3x magnification
Hi-tech touch control
Translucent acrylic frame
Full pivotal adjustment
Class I
100-240 V
Hard wire application
Brass construction

IP44



Standmodell
chrom, ø 240 mm /
Free standing
chrome, ø 240 mm

020759

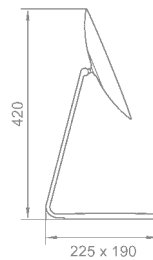

Am Schwenkarm
chrom, ø 240 mm /
On single arm
chrome, ø 240 mm

020758

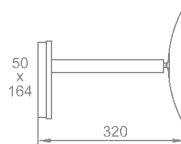

product concept + design: sieger design



LED MOON DANCE

Transluenter Acryl-Rahmen /
Translucent acrylic housing

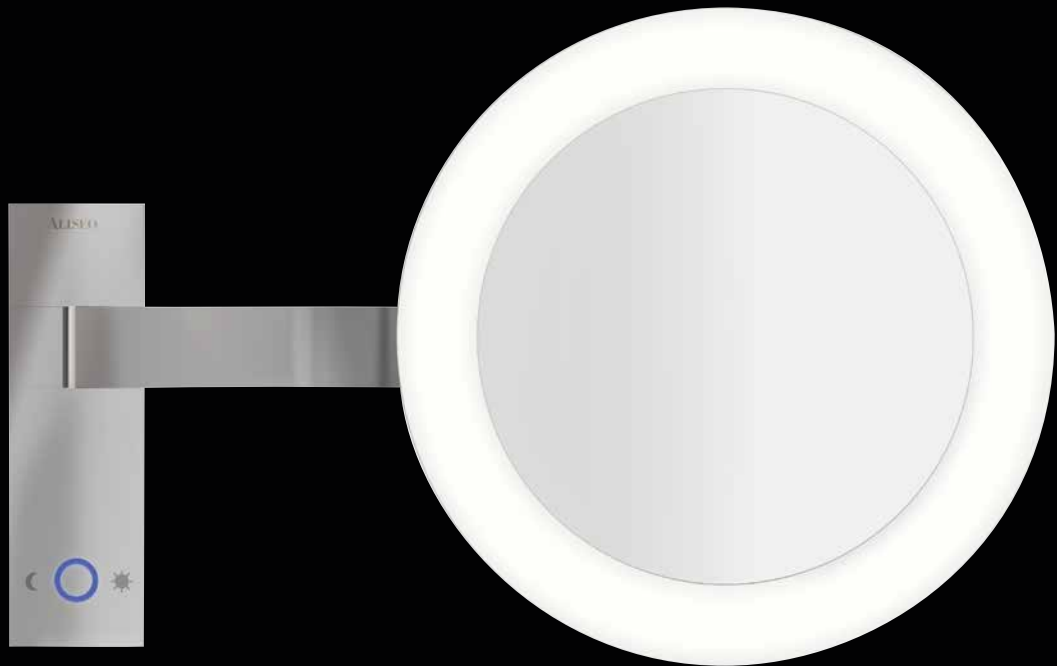

Tastschalter aktiviert wahlweise ein
warmweißes oder kühles weißes Licht /
Touch sensor offers the choice of a
warm white or cool white reflection



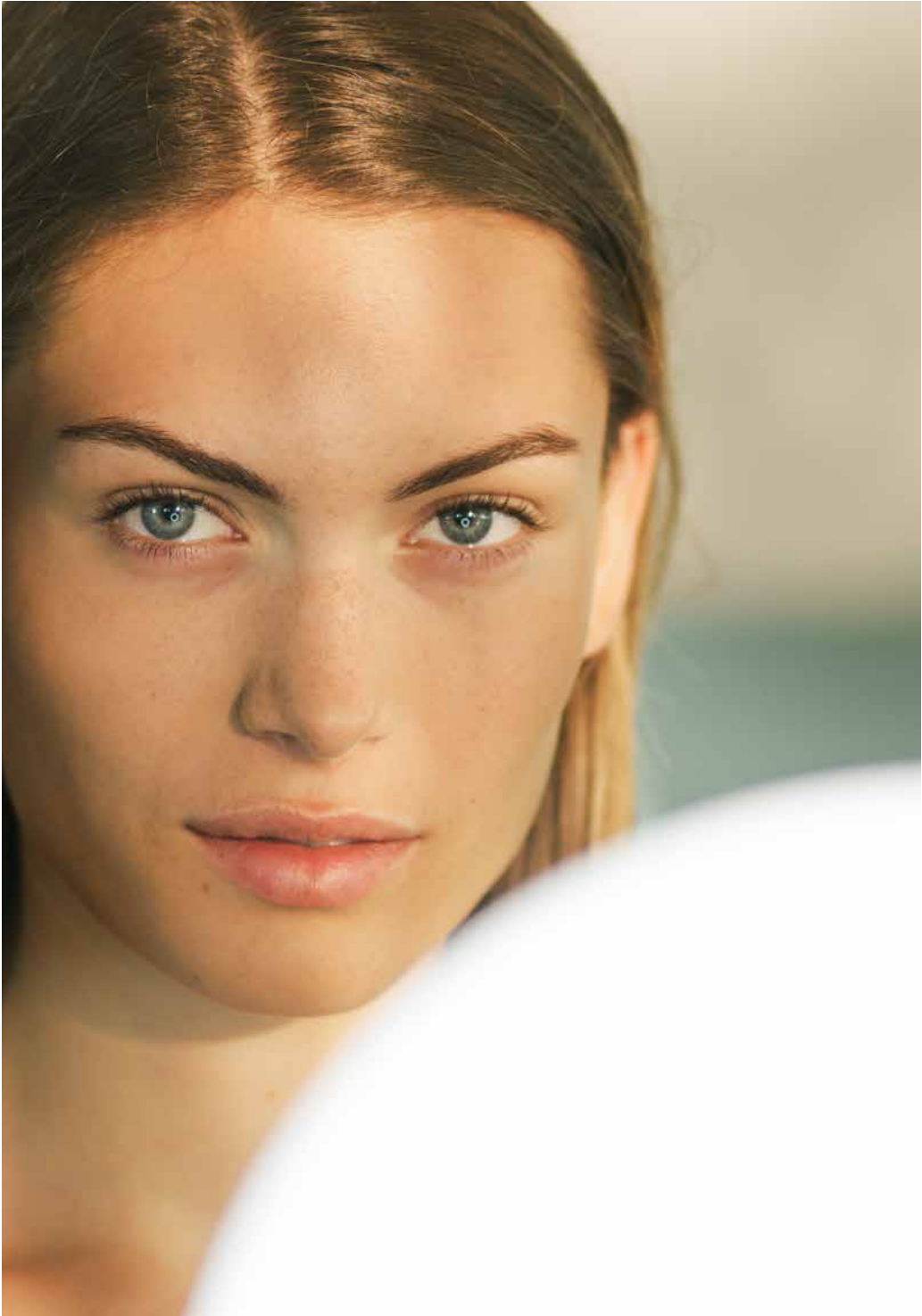

LED MOON DANCE

SMD-LED-Beleuchtung
 Warmweißes Licht, 3500-4000 K
 Kühles weißes Licht, 5000-5500 K
 3-fach-Vergrößerung
 High-Tech-Tastschalter
 Transluenter Acryl-Rahmen
 Kugelgelenk
 Schutzklasse I - Kontrollbox
 100-240 V
 Direktanschluss
 Messingkonstruktion

SMD-LED-lighting
 Warm white light, 3500-4000 K
 Cool white light, 5000-5500 K
 3x magnification
 Hi-tech touch control
 Translucent acrylic frame
 Full pivotal adjustment
 Class I - control box
 100-240 V
 Hard wire application
 Brass construction

IP44



Wandstange
 chrom, ø 240 mm /
 Wall bar
 chrome, ø 240 mm
020817

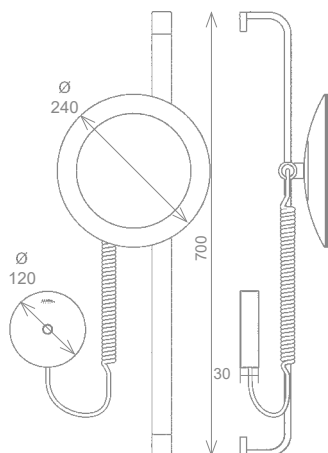

Transluenter Acryl-Rahmen /
 Translucent acrylic housing

T3 Kontrollbox /
 T3 Control Box



Technology
 Two-Tone-Touch



Green Efficiency



Die revolutionäre T³ Beleuchtung verwendet zwei LED Systeme mit spezifischer weißer/warmweißer Lichtfarbe. Der Gast hat die Option der Farbwahl. Elektrische Komponenten sind im Inneren des Lichtkreises angebracht, um eine schattenfreie Reflexion zu ermöglichen. (Standardausführung bei den Kosmetikspiegeln SATURN, CUBIK und MOON DANCE.) /

Revolutionary T³ lighting utilizes two independent SMD-LED systems with different light emitting pigmentations. Two-Tone-Touch lighting offers the user the choice of a shadow-free brighter daytime look or a warmer more polished night-time appearance. (Standard on SATURN, CUBIK and MOON DANCE mirrors.)

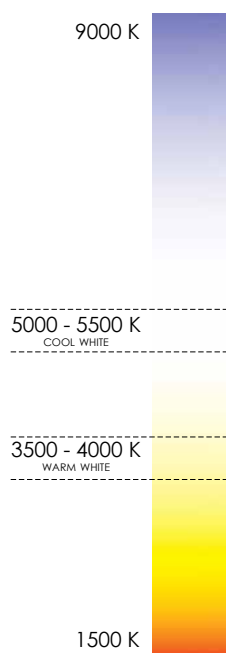

KELVIN FARBSPEKTRUM / KELVIN COLOR SPECTRUM

Da LEDs keine Wärme benötigen, um Licht zu erzeugen, wird deren Farbtemperatur anhand der Lichtfarbe errechnet.

Die Kosmetikspiegel CITY LIGHT, CUBIK LIMITED, VISION, LUNATEC, und LUNATEC MINIMALIST haben ein warmweißes Licht von 3500 bis 4000 Kelvin.

Aliseo's T³ Kosmetikspiegel SATURN, CUBIK und MOON DANCE haben zwei Farbtöne, ein warmweißes Licht von 3500 bis 4000 Kelvin und ein kühles weißes Licht von 5000 bis 5500 Kelvin. /

Because LEDs do not use heat to create light, their color temperature is estimated in relation to the color of the light.

Aliseo mirrors CITY LIGHT, CUBIK LIMITED, VISION, LUNATEC, and LUNATEC MINIMALIST have a warm white light of 3500 - 4000 Kelvins.

Aliseo T³ mirrors SATURN, CUBIK, MOON DANCE have dual tones a warm white light of 3500 - 4000 Kelvins and a cool white light of 5000 - 5500 Kelvins.

NEW MATERIALS & DESIGNS



Die SMD Platinen Technik hat es Aliseo's Designern ermöglicht, die minimalistischen und ultraflachen Spiegel zu entwickeln. Neue Materialien können nun eingesetzt werden und perfektionieren die unverwechselbare Ästhetik der jeweiligen Spiegel.

Individualisierung des Hotelbads mit Design, Materialien und Details

Bei „MOON DANCE“, von Star Designer Dieter Sieger konzipiert, ist das Highlight der aus transluzenten Acrylglas gefertigte Lichtkörper. Eine weitere Abwandlung der gleichen Lichtkonzeption, aber mit abgerundeten Kanten, ist das Modell Vision. Beide Modelle ließen sich erst durch den Einsatz von SMD Platinen erfolgreich realisieren.

* Alle Spiegel sind in verchromter Ausführung erhältlich. Je nach Menge und Ausführung sind Sonderanfertigungen möglich. /

SMD LED technology has created a new world of design possibilities that offer greater flexibility, aesthetic performance and design freedom.

The increased intensity of the light and extremely thin SMD lighting platform has enabled the usage of new materials and more advanced designs. Aliseo understands the integrity and relationship of different materials that combine clarity of purpose with utilitarian beauty.

Individualizing the Bathroom with Design, Materials and Detail

The Sieger designed MOON DANCE uses a molded translucent acrylic canopy that emits a distinctive backside ambient light while the VISION features distinctive transparent acrylic edge-lit imaging. Both are powered by flexible SMD-LED lighting strips.

* All mirrors available in chrome finish. Special custom finishes available depending on quantity and finish selected.



NU finishes





The **finish** completes the Design

Das NU-Finish-Sortiment ergänzt die hervorragende Handwerkskunst von Aliseo mit einer beeindruckenden Auswahl an Farben und Oberflächen. Ein perfekt integriertes persönliches Statement, das die koordinierte Transformation der Komponenten des Raumes als Ganzes vervollständigt.

Die PVD-Beschichtungstechnik erzeugt eine brillante, dekorative und dauerhafte Beschichtung, die einfach zu reinigen, kratzfest und korrosionsbeständig und mit fast jeder gewünschten Oberfläche kompatibel ist - matt, gebürstet oder poliert. /

NU finish assortment complements Aliseo's superlative craftsmanship with a commanding range of colors that conforms to the finish of choice. A perfectly integrated personal statement that completes the coordinated transformation of the components of the room as a whole. Aliseo utilizes PVD - a Physical Vapor Deposition high-tech process that produces a brilliant decorative and durable coating. Simple to clean and highly resistant to scratches, NU finishes are available in an almost endless variety of colors and surfaces - matt, brushed or polished and are compatible with virtually any provided designated finish.



Die NU-Oberflächen von Aliseo schaffen eine frische ästhetische Performance, die die unverwechselbare Persönlichkeit des Spiegels ausstrahlt und gleichzeitig die Auswahlmöglichkeiten für den Hotelier erweitert. Die Farbanpassung ist mit jeder vorgesehenen Oberfläche kompatibel.

Garantie auf die Oberfläche: 10 Jahre auf die Chromoberfläche, 5 Jahre auf die PVD-Oberfläche, 2 Jahre auf die Pulverbeschichtung - vorausgesetzt, die allgemeinen Aliseo-Pflegehinweise werden befolgt. /

Aliseo's NU finishes create a fresh aesthetic performance that radiates the distinctive personality of the mirror while expanding the choices available to the hotelier. Color match is compatible with any provided designated finish.

Warranty on Surface: 10 years Chrome Finish, 5 years on PVD Finish, 2 years on Powder Coating - provided general Aliseo maintenance guidelines are followed.



LED MOONDANCE
poliertes Messing / polished brass



LED INTERFACE
Nickel gebürstet / brushed nickel poliertes Messing / polished brass chrom / chrome



Something for Everyone

NU-Oberflächen sind in einer nahezu unbegrenzten Auswahl an Farben und Oberflächen erhältlich, die mit dem Metallmuster des gewünschten Armaturenherstellers übereinstimmen. Die Farbkoordinaten werden über ein 3-dimensionales Farbfotometer extrahiert. Die Werte werden nun berechnet, der Spiegel in eine Kammer gelegt und der PVD-Prozess beginnt. Die Farbanpassung ist mit jeder vorgesehenen Oberfläche kompatibel. /

NU colors are available in an almost endless variety of surface colors that conform to the metal swatch obtained from the desired faucet manufacturer.

Color coordinates are extracted via a 3 dimensional color photometer. The values are now calculated, the mirror placed in a chamber and the PVD process begins. Color match is compatible with any provided designated finish.

(Unten sehen Sie nur einen Querschnitt einiger unserer beliebtesten Oberflächen) /

(Below is just a cross-section of some of our most popular finishes)

POLIERT / POLISHED



CHROM 100 /
CHROME 100



BRONZE 201



GOLDOPTIK 203 /
GOLD OPTIC 203



MESSING 206 /
BRASS 206



BRONZE 201



ROTGOLD 209 /
RED GOLD 209



CHROM SCHWARZ 211 /
BLACK CHROME 211

GEBÜRSTET / BRUSHED



CHROM 302 /
CHROME 302



BRONZE 301



GOLDOPTIK 303 /
GOLD OPTIC 303



MESSING 306 /
BRASS 306



BRONZE 301



ROTGOLD 309 /
RED GOLD 309



CHROM SCHWARZ 311 /
BLACK CHROME 311

Farbunterschiede aufgrund des Druckverfahrens vorbehalten.

Bitte gehen Sie auf unseren Konfigurator auf der NU-Finish Seite für eine operative Visualisierung. /

Subject to color differences due to the printing process.

Please go do our configurator NU finish page for an operational visualization.

LED SATURN
rotgold / red gold



COSMO MINIMALIST
schwarz / black

ME & MY

Be Yourself

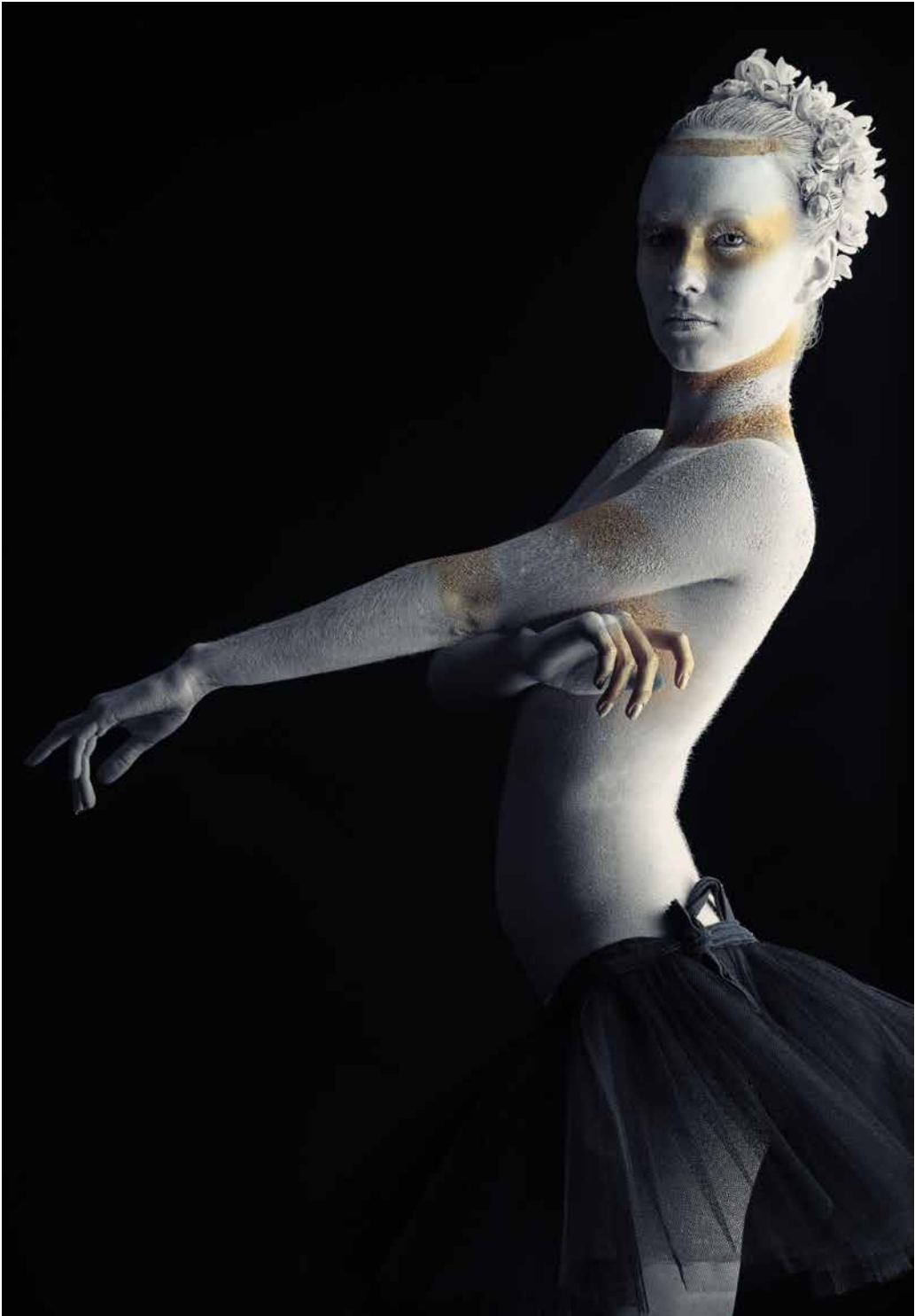



ME

Acryl-Hintergrundbeleuchtung
SMD-LED-Beleuchtung
Warmweißes Licht, 3500-4000 K
3-fach-Vergrößerung
Doppelwalzengelenk
Schutzklasse I
100-250 V
Direktanschluss

Acrylic - back light design
SMD-LED-lighting
Warm white light, 3500-4000 K
3x magnification
Multiple vertical, pivotal and
swing arm adjustment
Class I
100-250 V
Hard wire application



Am Schwenkarm
chrom, ø 220 mm /
On single arm
chrome, ø 220 mm
020835

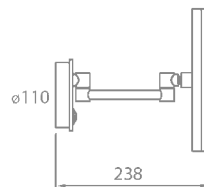

Am Doppel-Schwenkarm /
chrom, ø 220 mm
On twin arm
chrome, ø 220 mm
020836

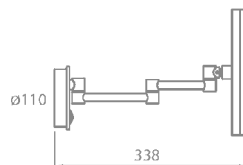

Green Efficiency

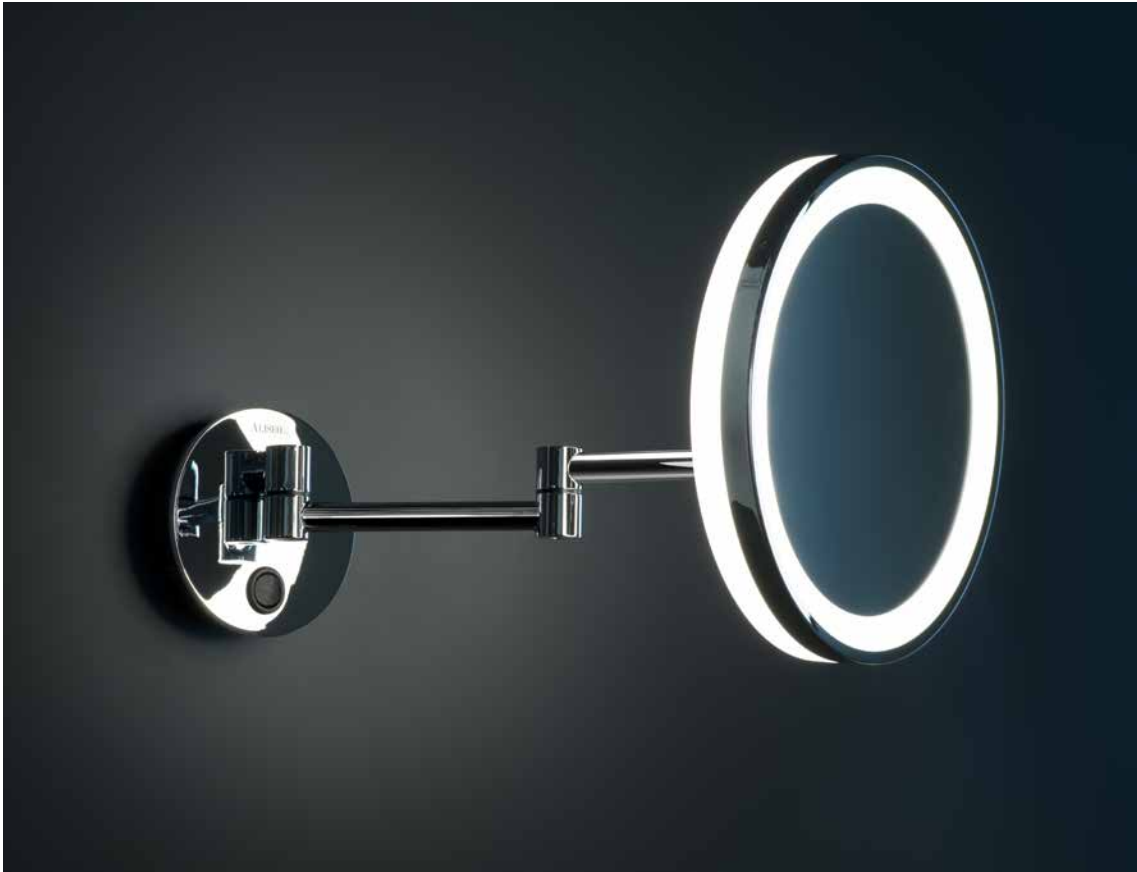

Mit Acryl-Hintergrundbeleuchtung / With acrylic-back light design



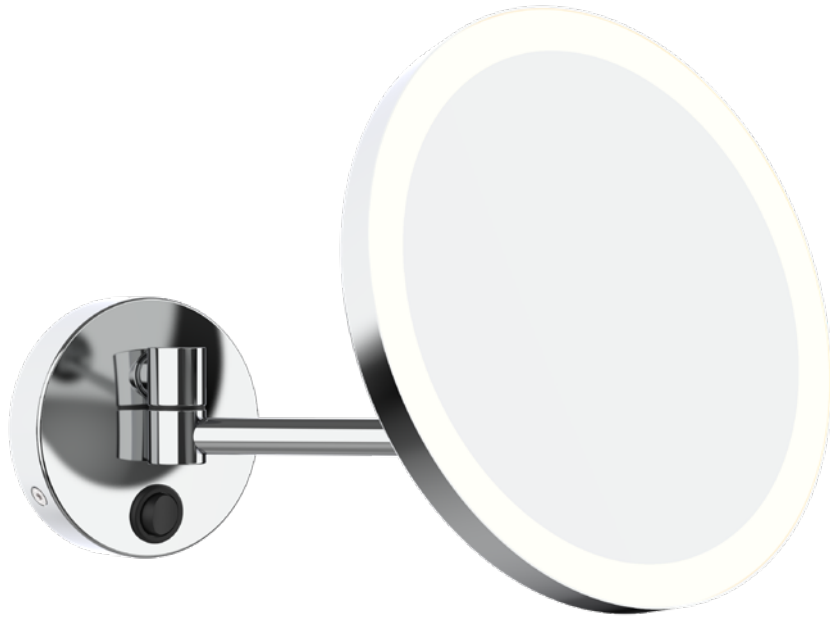

MY

SMD-LED-Beleuchtung
 Warmweißes Licht, 3500-4000 K
 3-fach-Vergrößerung
 Doppelwalzengelenk
 Schutzklasse I
 100-250 V
 Direktanschluss

SMD-LED-lighting
 Warm white light, 3500-4000 K
 3x magnification
 Multiple vertical, pivotal and
 swing arm adjustment
 Class I
 100-250 V
 Hard wire application



Am Schwenkarm
 chrom, ø 220 mm /
 On single arm
 chrome, ø 220 mm
020843

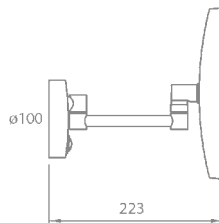

Am Doppel-Schwenkarm
 chrom, ø 220 mm /
 On twin arm
 chrome, ø 220 mm
020844

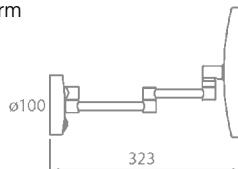



Maximale Einstellbarkeit in einem vollverchromten Gehäuse. /
Maximum adjustability in a full chrome housing.



Green Efficiency





THE MIRROR HAS TWO FACES

The Ultimate in Cosmetic Imaging

T3 Technology verwendet zwei LED Systeme mit spezifischer weißer/ warmweißer Lichtfarbe. Der Gast hat die Wahl zwischen Tages- oder Abendbeleuchtung. /

T3 Technology integrates two independent systems with different light reflective pigmentations offering the user their choice of a cool bright daytime look or a warm night time reflection.

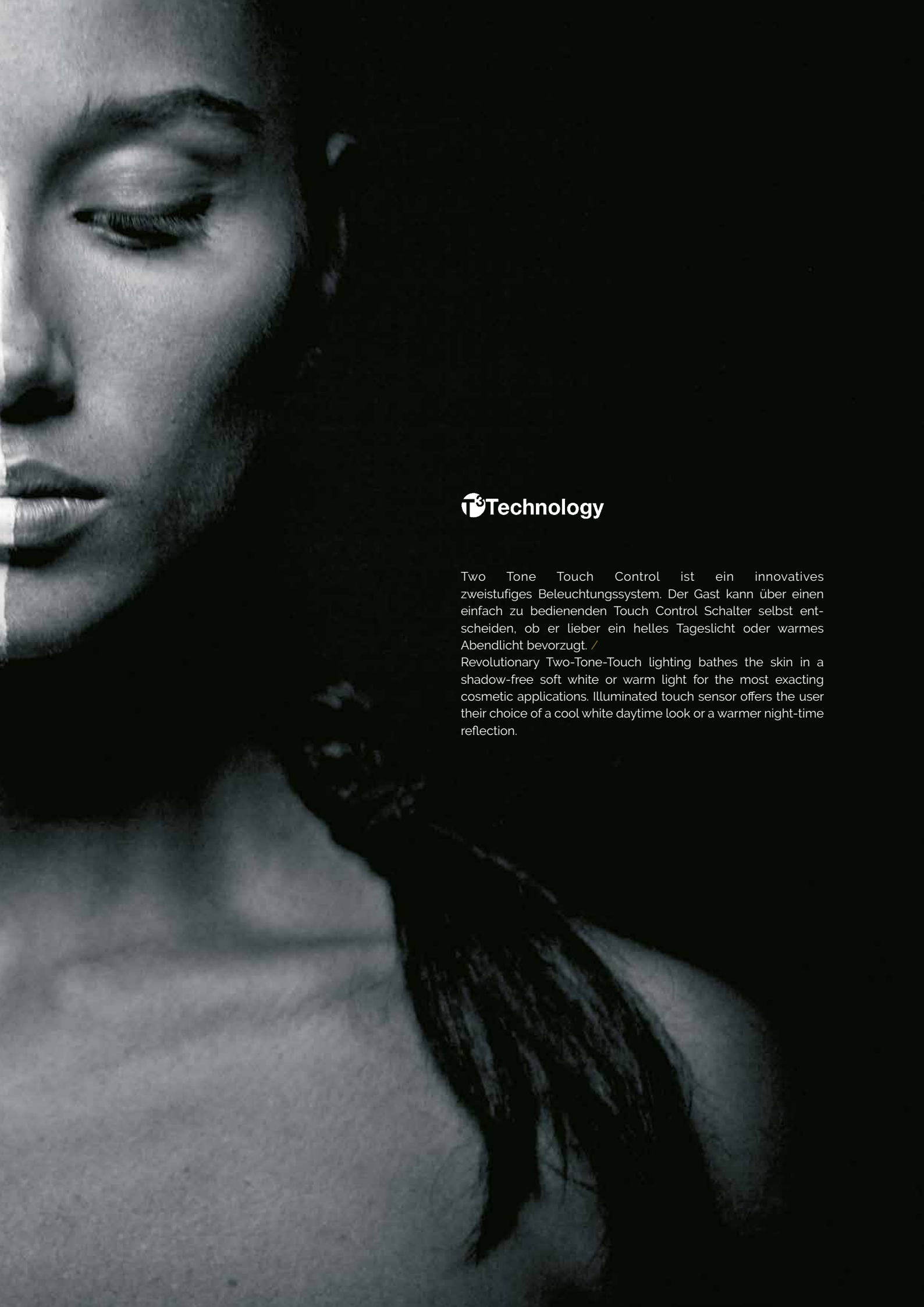

Technology

Two Tone Touch Control ist ein innovatives zweistufiges Beleuchtungssystem. Der Gast kann über einen einfach zu bedienenden Touch Control Schalter selbst entscheiden, ob er lieber ein helles Tageslicht oder warmes Abendlicht bevorzugt. /

Revolutionary Two-Tone-Touch lighting bathes the skin in a shadow-free soft white or warm light for the most exacting cosmetic applications. Illuminated touch sensor offers the user their choice of a cool white daytime look or a warmer night-time reflection.

LED SATURN



Beleuchteter Tastschalter /
Illuminated touch sensor

Perfekte Ausleuchtung
bis zu 50.000 h wartungsfreie Beleuchtung /
LED pin-point reflection
up to 50,000 hour maintenance free illumination

"The Mirror Has Two Faces"



Green Efficiency



Technology
Two-Tone-Touch

Zwei unabhängige LED-Beleuchtungssysteme mit Tages- oder
Abendbeleuchtung /
Two independent LED systems with light reflective pigmentation



rotgold / red gold

LED SATURN

SMD-LED-Beleuchtung
 Warmweißes Licht, 3500-4000 K
 Kühles weißes Licht, 5000-5500 K
 3-fach-Vergrößerung
 High-Tech-Tastschalter
 Kugelgelenk
 Schutzklasse I
 100-240 V
 Direktanschluss
 Messingkonstruktion
IP44



SMD-LED-lighting
 Warm white light, 3500-4000 K
 Cool white light, 5000-5500 K
 3x magnification
 Hi-tech touch control
 Full pivotal adjustment
 Class I
 100-240 V
 Hard wire application
 Brass construction

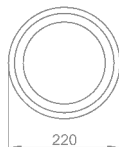

Am Schwenkarm
 chrom, ø 220 mm /
 On single arm
 chrome, ø 220 mm
020743

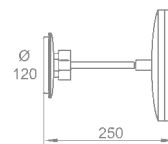

Am Doppel-Schwenkarm
 chrom, ø 220 mm /
 On Twin arm
 chrome, ø 220 mm
020744

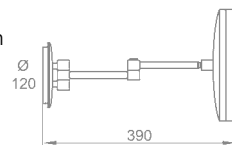





Stabiles Kugelgelenk für individuelle
Verstellbarkeit /
Reinforced ball joint for full pivotal
imaging

"A Modern Day Classic"

Perfekte Ausleuchtung
bis zu 50.000 h wartungsfreie Beleuchtung /
LED pin-point reflection
up to 50,000 hour maintenance free illumination





chrom gebürstet /
brushed chrome

NU finishes

LED CUBIK

SMD-LED-Beleuchtung
Warmweißes Licht, 3500-4000 K
Kühles weißes Licht, 5000-5500 K
3-fach-Vergrößerung
High-Tech-Tastschalter
Kugelgelenk
Schutzklasse I
100-240 V
Direktanschluss
Messingkonstruktion
IP44



SMD-LED-lighting
Warm white light, 3500-4000 K
Cool white light, 5000-5500 K
3x magnification
Hi-tech touch control
Full pivotal adjustment
Class I
100-240 V
Hard wire application
Brass construction

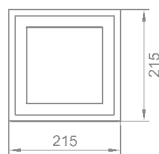

Am Schwenkarm
chrom, 215 x 215 mm /
On single arm
chrome, 215 x 215 mm
020745

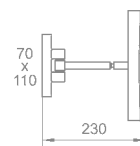

Am Doppel-Schwenkarm
chrom, 215 x 215 mm /
On twin arm
chrome, 215 x 215 mm
020746

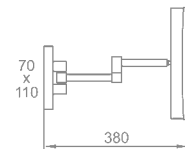

Standmodell
chrom, 215 x 215 mm /
Free standing
chrome, 215 x 215 mm
020747

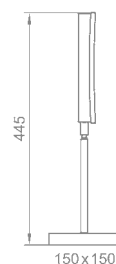

Wahlweise mit Tages- oder Abendbeleuchtung / Variable Day or Night time Illumination



Einzigartiger, beleuchteter Tastschalter /
Illuminated two-position touch sensor





COSMO CUBIK - Bold And Casual

Kompakte Formsprache mit Konzentration auf das Wesentliche. /
Compact sturdy physique with defined unpretentious lines.

Verstärktes Gelenk erhöht
Beständigkeit und Langlebigkeit /
Reinforced pivot pin adds
strength and durability



COSMO CUBIK

Plan- und
3-fach-Vergrößerung
Verdeckte Montageeinheit

Plain and
3x magnification
Covered backplate

Am verkürzten Doppel-Schwenkarm
chrom, 200 x 200 mm /
On shortened twin arm
chrome, 200 x 200 mm

020604

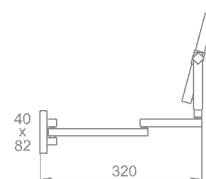
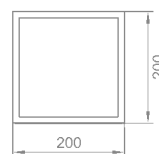

LED VISION

Wandhalterung mit integriertem
Tastschalter in schlanker Dreiecksform /
Low profile triangular wall bracket with
convenient integrated touch sensor



REFLECTION REDEFINED

Die puristische Schönheit dieses Spiegels entsteht durch die Harmonie seiner abgerundeten Kanten. Der transluzente Acrylring verstärkt die Lichtführung und prägt auf ganz besondere Weise das Gefühl von Anmut und zeitloser Eleganz. Die technische Raffinesse von Vision befindet sich in der selbstentwickelten SMD LED Beleuchtungsplatine, die leistungsstark und besonders energieeffizient ist. /

Gently curved profile framed by stunning edge-lit LED acrylics turns a room into a vibrant statement of personal taste. Aesthetic functionality at its finest; refined and durable twin-arm construction allows for a full range of motion and angular adjustments.

A re-imagination of a mirror reinvented.

Wartungsfreie Beleuchtung mit transluzenten Acrylring
mit abgerundeten Kanten /
Gently curved profile framed by unique acrylic-edge
LED lighting provides full maintenance-free illumination

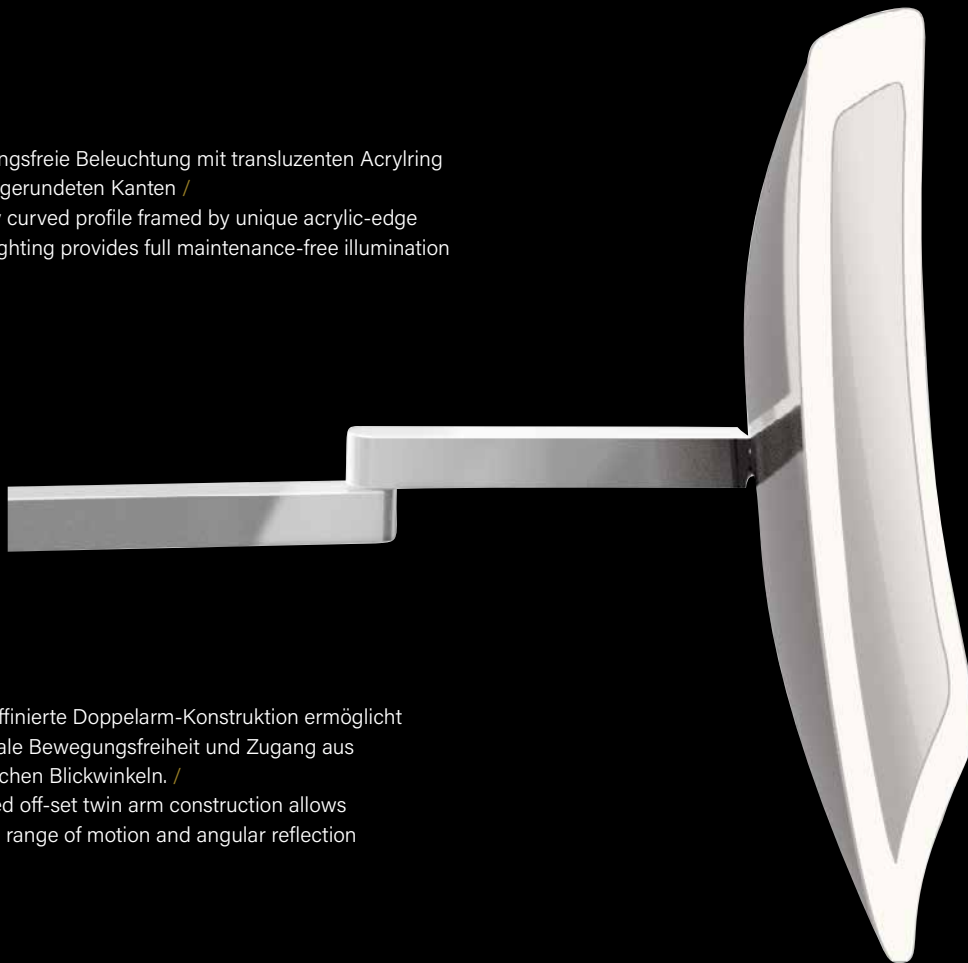

Die raffinierte Doppelarm-Konstruktion ermöglicht
optimale Bewegungsfreiheit und Zugang aus
sämtlichen Blickwinkeln. /
Refined off-set twin arm construction allows
for full range of motion and angular reflection



Green Efficiency

LED VISION

SMD-LED-Beleuchtung
Kühles weißes Licht, 5000-5500 K
3-fach-Vergrößerung
Kugelgelenk
High-Tech-Tastenschalter
Transluzenter Acryl-Rahmen
Schutzklasse I
100-240 V
Direktanschluss
Messing-Komponenten



SMD-LED-lighting
Cool white light, 5000-5500 K
3x magnification
Full pivotal adjustment
Hi-Tech touch control
Translucent acrylic frame
Class I
100-240 V
Hard wire application
Brass components

Am Doppel-Schwenkarm
chrom, 180 x 240 mm /
On Twin arm
chrome, 180 x 240 mm

020767

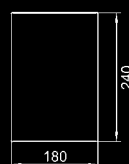
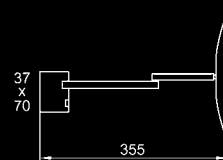

COSMO MINIMALIST



COSMO MINIMALIST

3-fach-Vergrößerung
Kugelgelenk
Standmodell
chrom, ø 200 mm /
3x magnification
Full pivotal adjustment
Free standing
chrome, ø 200 mm

020488

Leichte Ausrichtung /
Fingertip adjustment

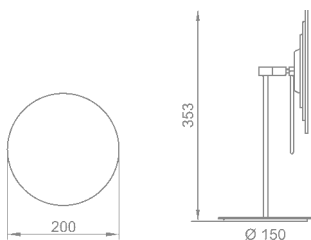



COSMO MINIMALIST

3-fach-Vergrößerung
Kippgelenk
Verdeckte Montageeinheit
Messing-Komponenten

3x magnification
Full pivotal adjustment
Covered backplate
Brass components

Am Schwenkarm
chrom, ø 200 mm /
On single arm
chrome, ø 200 mm
020607

Am Schwenkarm
pulverbeschichtet, schwarz matt
ø 200 mm /
On single arm
powder coating, black matt
ø 200 mm
020804

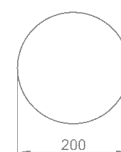
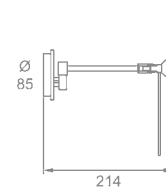



Ultra-schlankes, platzsparendes Design Flach an die Wand klappbar / Ultra slim space saving design Folds flat to the wall



FACE

3-fach-Vergrößerung
 Dreh-/ Kippgelenk
 Verdeckte Montageeinheit
 3x magnification
 Full pivotal adjustment
 Covered backplate

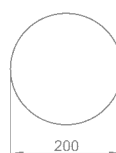

Am Schwenkarm
 chrom, ø 200 mm
 Adapterplatte für
 bessere Stabilität /
 On single arm
 chrome, ø 200 mm
 Adapter plate for
 improved stability

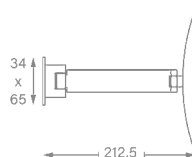

020831



Am Doppel-Schwenkarm
 chrom, ø 200 mm
 Adapterplatte für
 bessere Stabilität /
 On twin arm
 chrome, ø 200 mm
 Adapter plate for
 improved stability

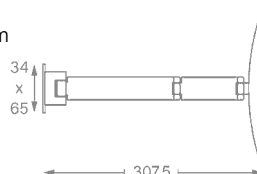

020829





Höhenverstellbar. Flach an die Wand klappbar / Height adjustable. Folds flat to the wall



FACE plus

3-fach-Vergrößerung
 Höhenverstellbar mit
 Schwenkeinstellungen
 Schwenkarm an die Wand klappbar
 Verdeckte Montageeinheit
 Verdeckte Schrauben

3x magnification
 Height adjustable with
 pivotal adjustments
 Swivel arm folds to the wall
 Covered mounting bracket
 Concealed screws

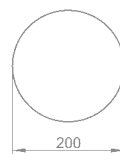

Am Schwenkarm
 Montage rechts
 chrom, ø 200 mm /
 On single arm
 right mounting
 chrome, ø 200 mm

020834

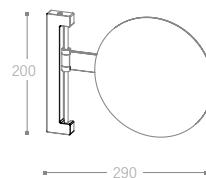

Am Schwenkarm
 Montage links
 chrom, ø 200 mm /
 On single arm
 left mounting
 chrome, ø 200 mm

020837

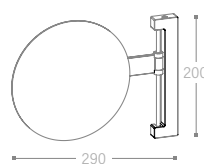

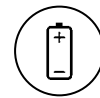

batteriebetrieben /
battery powered

Batteriebetrieben, 4 x AA
Akkubatterie oder Trocken-
batterie mit Anzeige bei
schwacher Batterie
Leicht zugängliches Batterie-
fach mit Schnappschloss /
Powered by 4 x AA dry or
rechargeable batteries complete
with a low power indicator
Easily accessible snap-cover
battery compartment





INTERFACE - Look & See

Automatisches Einschalten durch Gesichtsannäherung
Ein Infrarot-Sensor aktiviert die automatische Ein-/Ausschaltung
der LED-Beleuchtung im transluzenten Acrylrings
im Abstand von 20 cm /

Lights automatically as your face approaches
Auto ON/OFF infrared sensor activates a translucent
acrylic edge LED lighting system.
Operational up to 20 cm.



Sensor



batteriebetrieben /
battery powered



automatische Ausschaltfunktion
nach 15 Sek. / automatic switch
-off after 15 sec.

LED INTERFACE



A Much Appreciated Affordable Upgrade

INTERFACE zeichnet sich durch ein elegantes effizientes minimalistisches Design mit integrierter vertikaler Einstellung aus. Die transluzente Acryl-LED-Beleuchtung strahlt mit einem warmen, natürlichen, bernsteinfarbenen Schimmer. /

INTERFACE features an elegantly efficient minimalist design with an integrated vertical slot adjustment. Translucent acrylic LED lighting emits a warm natural amber glow.



Sensor



batteriebetrieben /
battery powered



automatische Ausschaltfunktion
nach 15 Sek. / automatic switch
-off after 15 sec.

LED INTERFACE

SMD-LED-Beleuchtung
Warmweißes Licht, 3500-4000 K
3-fach-Vergrößerung
Verstärktes Dreh-/Kippgelenk
Batteriebetrieben
Messing-Komponenten

SMD-LED-lighting
Warm white light, 3500-4000 K
3x magnification
Sturdy reinforced pivot joint
Battery powered
Brass components

Standspiegel
chrom, ø 220 mm /
Freestanding
chrome, ø 220 mm
020797

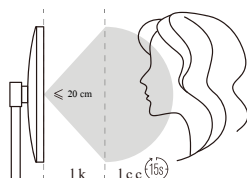
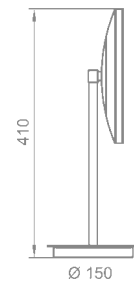

Am Schwenkarm
chrom, ø 220 mm
Adapterplatte für
bessere Stabilität /
On single arm
chrome, ø 220 mm
Adapter plate for
improved stability
020832

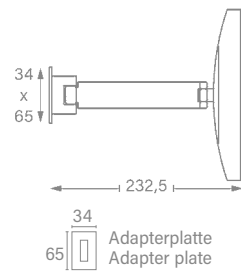



LED CITY LIGHT

SMD-LED-Beleuchtung
 Warmweißes Licht, 3500-4000 K
 3-fach-Vergrößerung
 Doppelwalzengelenk
 Schutzklasse I
 120-240 V
 Direktanschluss

SMD-LED-lighting
 Warm white light, 3500-4000 K
 3x magnification
 Full pivotal adjustment
 Class I
 120-240 V
 Hard wire application



Am Doppel-Schwenkarm
 chrom, ø 250 mm /
 On twin arm
 chrome, ø 250 mm
020657

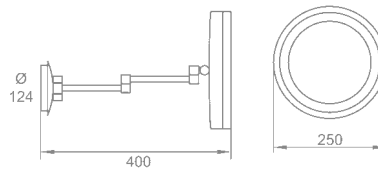

Am Schwenkarm
 chrom, ø 250 mm /
 On single arm
 chrome, ø 250 mm
020677

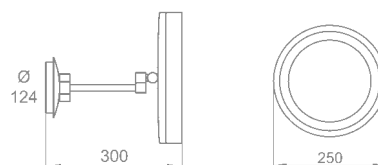



"Lighting The Way"

Großzügiger 25 cm Durchmesser / Generous 25 cm diameter

Perfekte Ausleuchtung bis zu 50.000 h wartungsfreie Beleuchtung /
LED pin-point reflection up to 50,000 hour maintenance free illumination



Green Efficiency





LED LUNATEC

SMD-LED-Beleuchtung
 Warmweißes Licht, 3500-4000 K
 3-fach-Vergrößerung
 Doppelwalzengelenk
 Schutzklasse I
 100-240 V
 Direktanschluss
 Messing-Komponenten
 ▶ 110 V auf Anfrage

IP44



SMD-LED-lighting
 Warm white light, 3500-4000 K
 3x magnification
 Full pivotal adjustment
 Class I
 100-240 V
 Hard wire application
 Brass components
 ▶ 110 V upon request

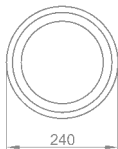

Am Schwenkarm
 chrom, ø 240 mm /
 On single arm
 chrome, ø 240 mm
020600

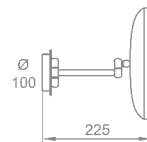

Am Doppel-Schwenkarm
 chrom, ø 240 mm /
 On twin arm
 chrome, ø 240 mm
020601

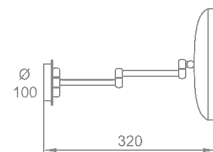



"Contemporary And Efficient"



Perfekte Ausleuchtung
bis zu 50.000 h wartungsfreie
Beleuchtung /
LED pin-point reflection
up to 50,000 hour maintenance
free illumination

Space Saving - Multiflex Fold-Away Design



CONCIERGE COLLECTION A Clear First Impression

Ein wartungsfreies, klassisches Sortiment,
das sich perfekt in jedes Ambiente
integrieren lässt. /

A serviceable assortment designed
to enhance the mood of any
space.

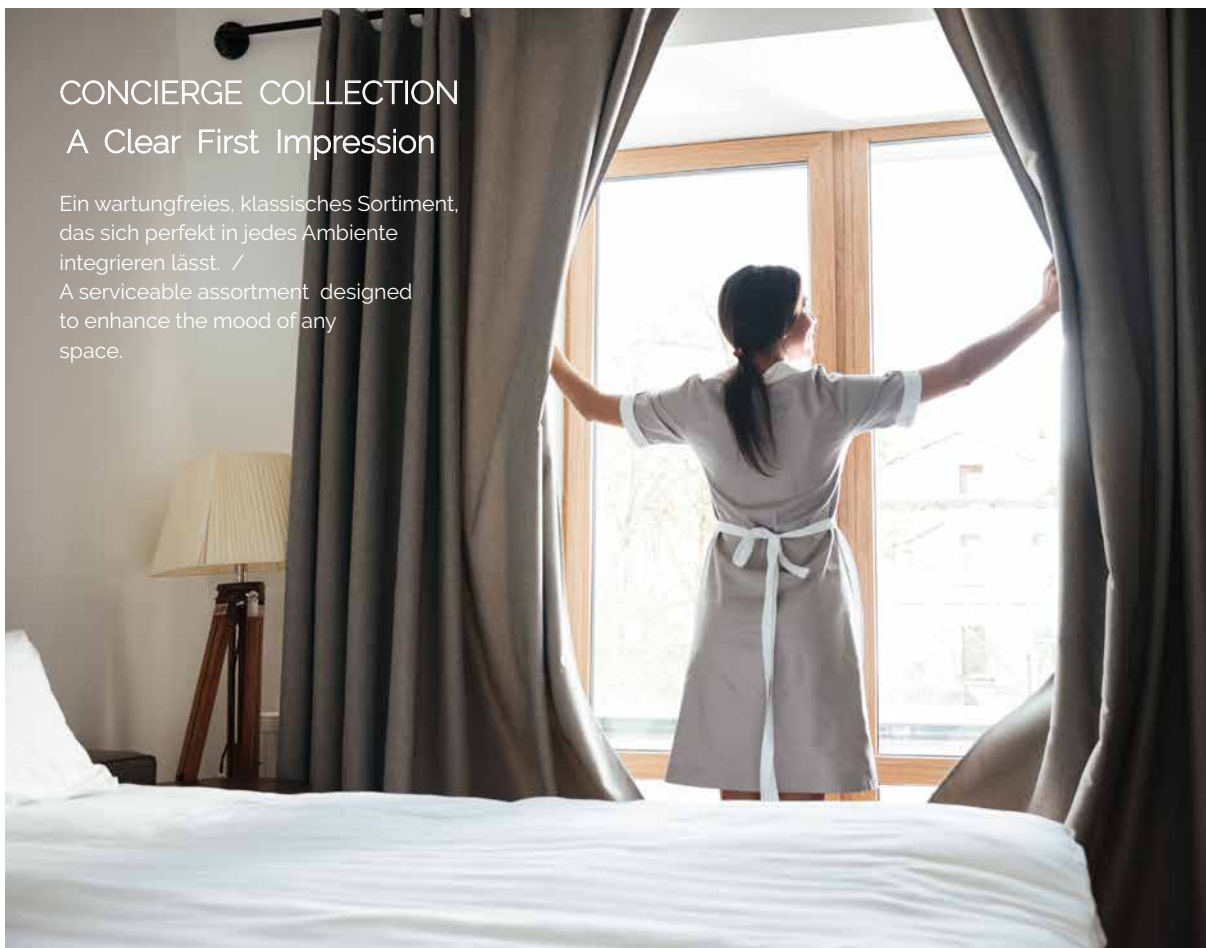

Höhenverstellbar /
Height adjustable



Plan- und 3-fach-Vergrößerung
Höhenverstellbar
Verdeckte Montageeinheit
Messing-Komponenten
Am Schwenkarm
chrom, ø 200 mm /
Plain and 3x magnification
Height adjustable
Covered backplate
Brass components
On single arm
chrome, ø 200 mm

020597

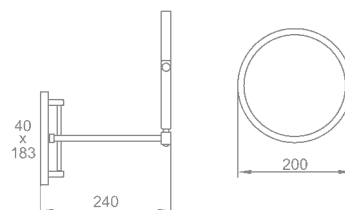

Plan- und 3-fach-Vergrößerung
 Verdeckte Montageeinheit
 Messing-Komponenten
 Am Schwenkarm
 chrom, ø 200 mm /
 Plain and 3x magnification
 Covered backplate
 Brass components
 On single arm
 chrome, ø 200 mm
020506

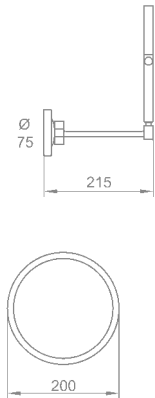

SICHERE BEFESTIGUNG
 ■ Separate Montageeinheit
 ■ Maximale Stabilität
 ■ Perfekt in Funktion und Design /
SECURE MOUNTING
 ■ Separate mounting bracket
 ■ Maximum stability
 ■ A finished elegant appearance

Am Doppel-Schwenkarm
 chrom, ø 200 mm /
 On twin arm
 chrome, ø 200 mm
020507

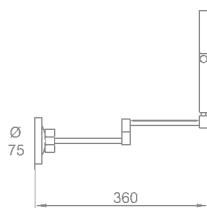



Modellübersicht / Product Overview

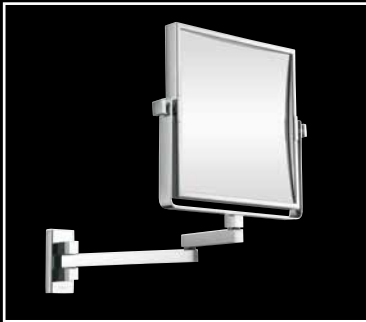

020604 COSMO CUBIK

200 x 200 mm. Ausgestreckt 320 mm
200 x 200 mm. Extends to 320 mm

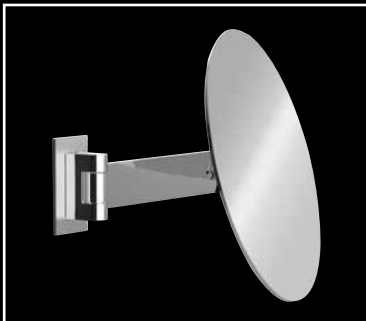

020831 FACE

ø 200 mm. Ausgestreckt 212,5 mm
ø 200 mm. Extends to 212,5 mm

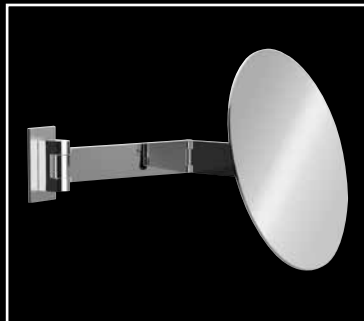

020829 FACE

ø 200 mm. Ausgestreckt 307,5 mm
ø 200 mm. Extends to 307,5 mm

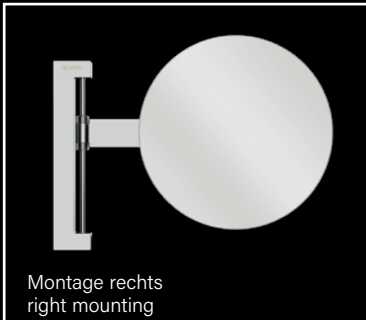

Montage rechts
right mounting

020834 FACE plus

ø 200 mm. Ausgestreckt 290 mm
ø 200 mm. Extends to 290 mm

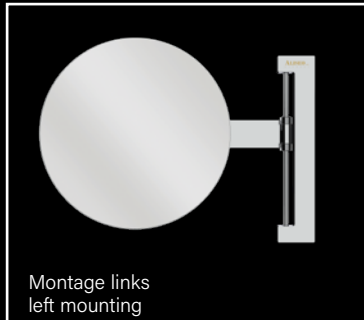

Montage links
left mounting

020837 FACE plus

ø 200 mm. Ausgestreckt 290 mm
ø 200 mm. Extends to 290mm



Modellübersicht / Product Overview

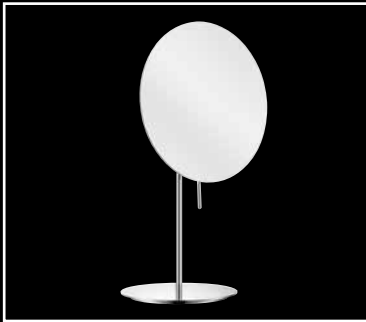

020488 COSMO MINIMALIST
ø 200 mm. Höhe 353 mm
ø 200 mm. Height 353 mm

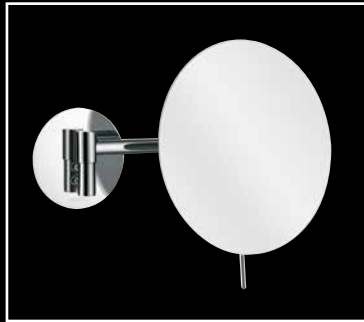

020607 COSMO MINIMALIST
ø 200 mm. Ausgestreckt 214 mm
ø 200 mm. Extends to 214 mm

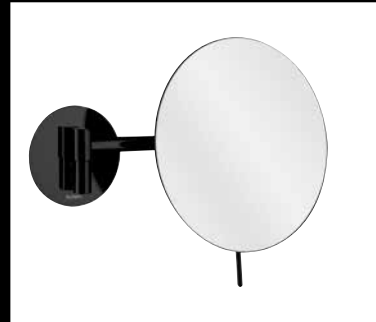

020804 COSMO MINIMALIST
ø 200 mm. Ausgestreckt 214 mm
ø 200 mm. Extends to 214 mm



020506 CONCIERGE
ø 200 mm. Ausgestreckt 215 mm
ø 200 mm. Extends to 215 mm



020507 CONCIERGE
ø 200 mm. Ausgestreckt 360 mm
ø 200 mm. Extends to 360 mm



020597 CONCIERGE
ø 200 mm. Ausgestreckt 240 mm
ø 200 mm. Extends to 240 mm

Alle Spiegel in verchromter Oberfläche.
Erhältlich in anderen Ausführungen. /
All mirrors in chrome finish.
Available in other finishes.



Modellübersicht / Product Overview

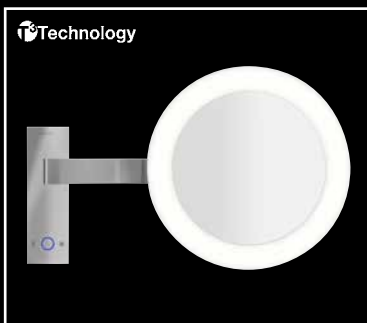

020758 LED MOON DANCE
ø 240 mm. Ausgestreckt 320 mm
ø 240 mm. Extends to 320 mm



020759 LED MOON DANCE
ø 240 mm. Höhe 420 mm
ø 240 mm. Height 420 mm



020817 LED MOON DANCE
ø 240 mm. Höhe 700 mm
ø 240 mm. Height 700 mm



020743 LED SATURN
ø 220 mm. Ausgestreckt 250 mm
ø 220 mm. Extends to 250 mm



020744 LED SATURN
ø 220 mm. Ausgestreckt 390 mm
ø 220 mm. Extends to 390 mm

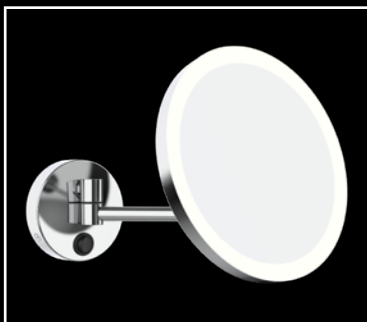

020843 MY
ø 220 mm. Ausgestreckt 223 mm
ø 220 mm. Extends to 223 mm

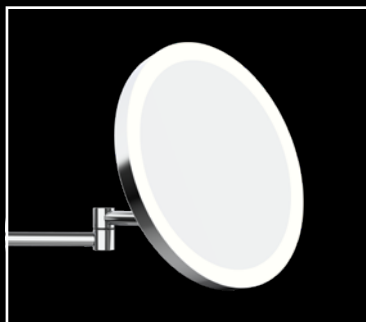

020844 MY
ø 220 mm. Ausgestreckt 323 mm
ø 220 mm. Extends to 323 mm

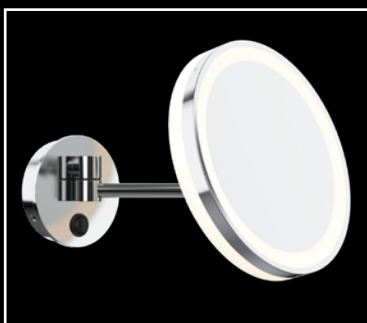

020835 ME
ø 220 mm. Ausgestreckt 238 mm
ø 220 mm. Extends to 238 mm

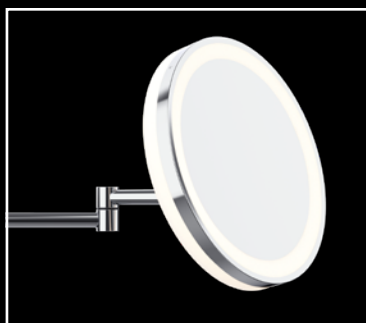

020836 ME
ø 220 mm. Ausgestreckt 338 mm
ø 220 mm. Extends to 338 mm



Technology
Two-Tone-Touch

Two Tone Touch Control ist ein innovatives zweistufiges Beleuchtungssystem. Der Gast kann über einen einfach zu bedienenden Tastschalter selbst entscheiden, ob er lieber ein helles Tageslicht oder warmes Abendlicht bevorzugt. / Two-Tone-Touch lighting bathes the skin in a shadow-free soft white or warm light for the most exacting cosmetic applications. Illuminated touch sensor offers the user their choice of a cool white daytime look or a warmer night-time reflection.



Modellübersicht / Product Overview



020745 LED CUBIK
215 x 215 mm. Ausgestreckt 230 mm
215 x 215 mm. Extends to 230 mm



020746 LED CUBIK
215 x 215 mm. Ausgestreckt 380 mm
215 x 215 mm. Extends to 380 mm



020747 LED CUBIK
215 x 215 mm. Höhe 445 mm
215 x 215 mm. Height 445 mm



020832 LED INTERFACE
ø 220 mm. Ausgestreckt 232,5 mm
ø 220 mm. Extends to 232,5 mm



020797 LED INTERFACE
ø 220 mm. Höhe 410 mm
ø 220 mm. Height 410 mm



020767 LED VISION
180 x 240 mm. Ausgestreckt 355 mm
180 x 240 mm. Extends to 355 mm

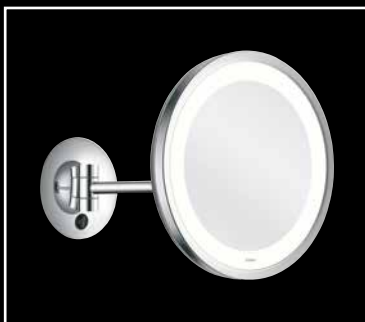

020677 LED CITY LIGHT
ø 250 mm. Ausgestreckt 300 mm
ø 250 mm. Extends to 300 mm



020657 LED CITY LIGHT
ø 250 mm. Ausgestreckt 400 mm
ø 250 mm. Extends to 400 mm



020600 LED LUNATEC
ø 240 mm. Ausgestreckt 225 mm
ø 240 mm. Extends to 225 mm



020601 LED LUNATEC
ø 240 mm. Ausgestreckt 320 mm
ø 240 mm. Extends to 320 mm

Alle Spiegel in verchromter Oberfläche.
Erhältlich in anderen Ausführungen. /
All mirrors in chrome finish.
Available in other finishes.