

I ELENCO RICAMBI



GB SPARE PARTS LIST

F LISTE DES PIÈCES DE RECHANGE



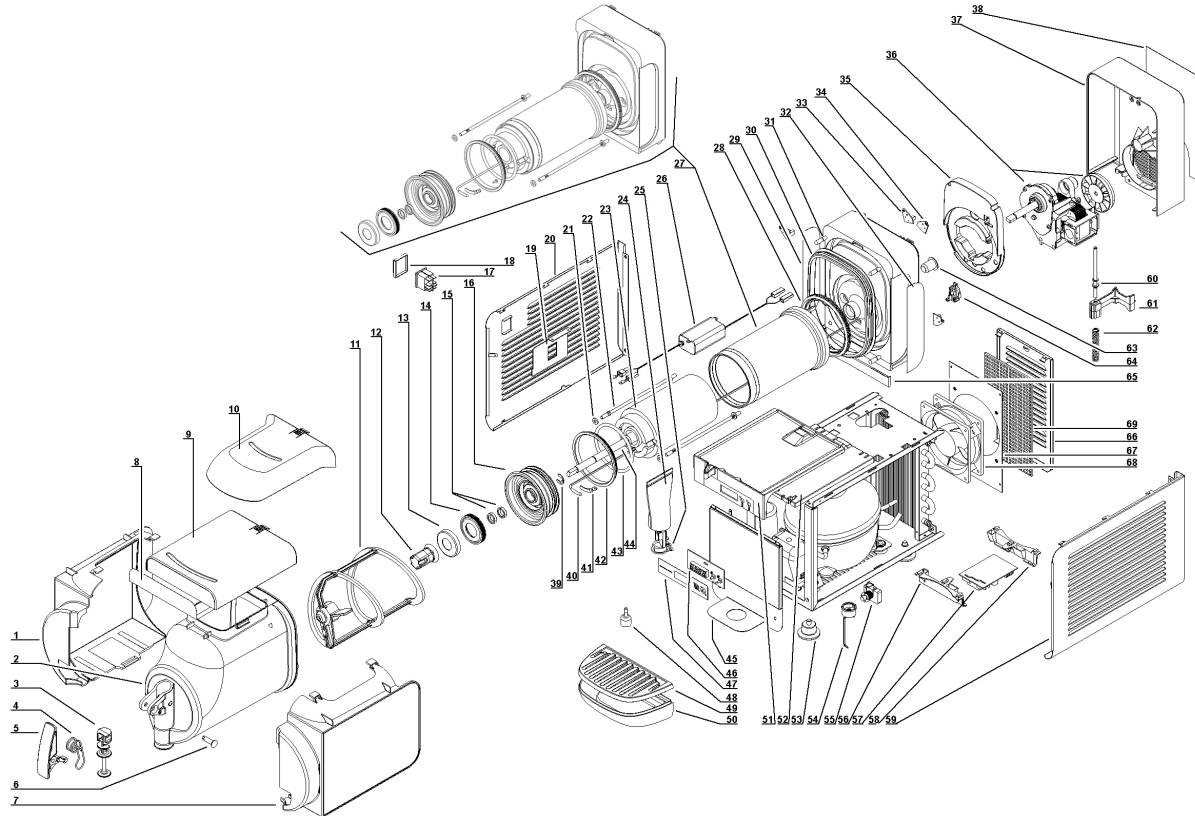

D ERSATZTEILLISTE

E DESCRIPCION PIEZAS DE REPUESTO



1	2W000-01300	Energy recover sx	Energy recover sx	Energy recover sx	Energy recover sx	Energy recover sx
2	2W000-01000	Contentitore	Bowl	Reservoir	Behälter	Recipiente
3	2Q000-01600	Pistone rubinetto	Faucet piston	Piston du robinet	Kolben des Zapfhahns	Pistón grifo
4	2Q000-02100	Molla rubinetto	Faucet spring	Ressort du robinet	Feder des Zapfhahns	Muelle grifo
5	2Q000-01500	Leva rubinetto	Faucet handle	Lever du robinet	Hebel des Zapfhahns	Palanca grifo
5	2Q000-01501	Leva rubinetto nera	Black faucet handle	Lever noir du robinet	Hebel schwarz des Zapfhahns	Palanca negro grifo
6	2Q000-05300	Perno per leva rubinetto	Pin for faucet handle	Pivot pour levier du robinet	Stift des Zapfahnhhebels	Perno para palanca grifo
6	2Q000-05301	Perno nero per leva rubinetto	Black pin for faucet handle	Pivot noir pour levier du robinet	Stift schwarz des Zapfahnhhebels	Perno negro para palanca grifo
7	2W000-01200	Energy recover dx	Energy recover dx	Energy recover dx	Energy recover dx	Energy recover dx
8	2Q000-07000	Fotografia per cappello	Picture for top cover	Photo pour couvercle	Foto für Abdeckplatte	Fotografía para cubierta
9	2W000-01100	Cappello	Top cover	Couvercle	Abdeckplatte	Cubierta
9	2W000-01102	Cappello bianco	White top cover	Couvercle	Abdeckplatte	Cubierta
9	2W000-01101	Cappello nero	Black top cover	Couvercle	Abdeckplatte	Cubierta
10	2W000-05000	Cappello	Top cover	Couvercle	Abdeckplatte	Cubierta
11	2W000-01400	Raschiatore esterno	Mixer	Raclor	Außerer Abstreifer	Raspador externo
12	2Q000-01900	Innesto esagonale per albero	Hexagonal coupling for shaft	Raccord hexagonal pour arbre	Sechskantanschluss der Welle	Embrague hexagonal para árbol
13	2Q000-06400	Calotta per tappo evaporatore	Cap for evaporator plug	Capuchon pour bouchon évaporateur	Deckelkappe Verdunstlers	Tapa para tapón evaporador
14	2Q000-06300	Guarnizione per tappo evaporatore	Gasket for evaporator plug cap	Joint du capuchon pour bouchon évaporateur	Dichtung der Deckelkappe Verdunstlers	Guarnición para tapa del tapón evaporador
15	22800-22615	Anello di tenuta	Sealing ring	Bague d'étanchéité	Dichtungsring	Anillo de estanqueidad
16	2Q000-02000	Tappo per evaporatore	Plug for evaporator	Bouchon d'évaporateur	Verdunsterdeckel	Tapón para evaporador
17	2W000-00800	Interruttore a 2 posizioni	2-position switch	Interrupteur à 2 positions	Wahlschalter mit 2 Positionen	Interruptor de 2 posiciones
17	2W000-00810	Interruttore a 2 posizioni (versione luce)	2-position switch (lighted version)	Interrupteur à 2 positions (vers. lumin)	Wahlschalter mit 2 Positionen (lighted version)	Interruptor de 2 posiciones (vers. luz)
18	2W000-00890	Protezione interruttore	Switch cap	Capuchon interrupteur	Schalterabdeckung	Protección interruptor
19	2W000-00500	Staffa supporto interruttori	Switch support bracket	Support de commutation	Stützwinkel wechseln	Soporte de soporte de interruptor
20	2W000-00300	Pannello laterale SX	Left side panel	Panneau latéral gauche	Linke Seitenverkleidung	Panel lateral IZQ
20	2W000-00301	Pannello nero laterale SX	Black left side panel	Panneau noir latéral gauche	Linke schwarze Seitenverkleidung	Panel negro lateral IZQ
21	10522-26000	Rondella piana Ø 6 x12,5 x2 inox	Flat washer	Rondelle plate	Flache Waschmaschine	Arandela plana
22	2W000-02600	Tirante per evaporatore	Evaporator tie-rod	Tirant pour évaporateur	Spanner Verdunstlers	Tensor para evaporador
23	2W000-02500	Coibentazione interna evaporatore	Evaporator inside insulation	Isolation interne de l'évaporateur	Innenisolierung des Verdunstlers	Aislamiento interno evaporador
24	22800-12701	Protezione passabloccacavo	Protection for terminal block for cable camp	Protecteur pour borne (avec fixation du câble)	Schutz Kabelklemmblock	Protección pasacable y bloqueador de cable
25	22800-05500	Passabloccacavo	Terminal block for cable camp	Borne avec fixation du câble	Kabelklemmblock	Pasacable y bloqueador de cable
26a		Alimentatore 12W-5V	12W-5V Power supply	Alimentation électrique 12W-5V	Stromversorgung 12W-5V	Fuente de alimentación 12W-5V
26b		Alimentatore 16W-5V	16W-5V Power supply	Alimentation électrique 16W-5V	Stromversorgung 16W-5V	Fuente de alimentación 16W-5V
27	3W000-00010	Evaporatore completo (versione luce)	Complete evaporator (lighted version)	évaporateur complet (vers. lumin)	Verdampfer komplette (lighted version)	evaporador completa (vers. luz)
27	3W000-00011	Evaporatore completo nero (versione luce)	Black complete evaporator (lighted version)	évaporateur noir complet (vers. lumin)	Verdampfer komplette schwarz (lighted version)	evaporador negro completa (vers. luz)
27	3W000-00000	Evaporatore completo	Complete evaporator	évaporateur complet	Verdampfer komplette	evaporador completa
27	3W000-00001	Evaporatore completo nero	Black complete evaporator	évaporateur noir complet	Verdampfer komplette schwarz	evaporador negro completa
28	22700-00100	Guarnizione posteriore	Rear gasket	Joint postérieur	Hintere Dichtung	Guarnición posterior
29	2W000-07200	Grafica laterale sx	Left side graphics	Graphiques de gauche	Grafik auf der linken Seite	Gáficos del lado izquierdo
30	2W000-01500	Guarnizione contenitore	Bowl gasket	Joint du réservoir	Behälterdichtung	Guarnición recipiente
31	2Q000-08500	Lente per LED	LED lens	Lentille de LED	LED linse	LED lente

32	2W000-07100	Grafica laterale dx	Right side graphics	Graphiques à droite	Grafik auf der rechten Seite	Gráficos del lado derecho
33	2U000-05610	Scheda LED sx	Left LED board	Gauche à LED	Left LED-Platine	Izquierda bordo LED
34	2U000-05600	Scheda LED dx	right LED board	conseil d'administration LED de droite	Recht LED-Platine	tablero adecuado LED
35	2W000-05100	Isolante spalla portaevaporatore	Rear wall insulation	Isolation paroi postérieure	Isolierung der Rückwand des Verdunsters	Aislante panel posterior soporte evaporador
36	3W000-00100	Motoriduttore completo 230/50	Complete gearmotor	Motoréducteur complet	Kompletter Getriebemotor	Motorreductor completo
36	3W000-00101	Motoriduttore completo 115/60	Complete gearmotor	Motoréducteur complet	Kompletter Getriebemotor	Motorreductor completo
37	2W000-01800	Coperchio spalla	Rear cover	Couvercle postérieur	Rückwandabdeckung	Tapa panel posterior
37	2W000-01801	Coperchio spalla nero	Black rear cover	Couverce noir postérieur	Rückwandabdeckung schwarz	Tapa negro panel posterior
38	2W000-07300	Fotografia coperchio per spalla	Picture for rear wall cover	Photo couvercle postérieur	Foto für Rückwandabdeckung	Fotografia tapa para panel posterior
39	2Q000-07401	Benzing Ø 10 UNI7434 DIN6799	Benzing Ø 10 UNI7434 DIN6799	Benzing Ø 10 UNI7434 DIN6799	Benzing Ø 10 UNI7434 DIN6799	Benzing Ø 10 UNI7434 DIN6799
40	22700-02900	Sonda di temperatura	Temperature probe	Sonde de température	Temperatursonde	Sonda de temperatura
41	22700-01001	Porta sonda di temperatura	Temperature probe holder	Support sonde de température	Halterung der Temperatursonde	Soporte sonda de temperatura
42	22700-00000	Guarnizione anteriore	Front gasket	Joint antérieur	Vordere Dichtung	Guarnición anterior
43	22700-02300	OR	OR	OR	O-Ring	OR
44	2W000-03500	Prolunga albero motore	Extension for motor shaft	Rallonge arbre moteur	Verlängerung der Motorwelle	Cable alargador árbol motor
45a		Pannello lato rubinetto	Dispensing side panel	Panneau côté robinet	Frontblech	Panel lado grifo
45b		Pannello nero lato rubinetto	Black dispensing side panel	Panneau noir côté robinet	Frontblech schwarz	Panel negro lado grifo
46	2W000-01700	Scheda display	Display card	Carte d'affichage	Display-Karte	Tarjeta display
47	2W000-01600	Adesivo tastiera	Keyboard stickers	Adhésif clavier	Aufkleber der Tastatur	Adhesivo teclado
47	2W000-01601	Adesivo nero tastiera	Black keyboard stickers	Adhésif noir clavier	Aufkleber schwarz der Tastatur	Adhesivo negro teclado
48	22900-06300	Galleggiante livello	Float level	Le niveau du flotteur	Schwimmer-	nivel de flotación
49	2W000-03100	Griglia cassetto raccogli gocce	Drip tray cover	Couvercle tiroir égouttoir	Tropfschalendeckel	Rejilla cajón recogedor de gotas
49	2W000-03101	Griglia nera cassetto raccogli gocce	Black drip tray cover	Couvercle noir tiroir égouttoir	Tropfschalendeckel schwarz	Rejilla negro cajón recogedor de gotas
50	2W000-03000	Cassetto raccogli gocce	Drip tray	Tiroir égouttoir	Tropfschale	Cajón recogedor de gotas
50	2W000-03001	Cassetto nero raccogli gocce	Black drip tray	Tiroir noir égouttoir	Tropfschale schwarz	Cajón negro recogedor de gotas
51	2W000-00700	Piano raccogli condensa	Condensate collection tray	Egouttoir supérieur	Wanne zum Auffangen des Kondenswassers	Plataforma recogedora de agua de condensación
51	2W000-00701	Piano nero raccogli condensa	Black condensate collection tray	Egouttoir noir supérieur	Wanne schwarz zum Auffangen des Kondenswassers	Plataforma negro recogedora de agua de condensación
52	2W000-00600	Coibentazione inferiore piano raccogli condensa	Lower insulation tray for condensate collection	Isolation inférieure égouttoir	Untere Isolierung der Wanne zum Auffangen des Kondenswassers	Aislamiento inferior plataforma recogedora de agua de condensación
53	22800-10000	Piedino livellatore	Leveling foot	Pied petit	Höhenverstellbares Füßchen	Pie nivelador
54	***	Relé	Relay	Relais	Start-Relais	Relé
55	***	Salvatore	Overload protector	Protège moteur	Motorsicherung	Guardamotor
56	2W000-05300	Supporto guida SX scheda di potenza	Left guideways support for power board	Support glissière gauche pour carte d'alimentation	Linke Halterung der Leistungsplatine	Soporte guía IZQ tarjeta de potencia
57a		Scheda di potenza 230/50	Power board	Carte d'alimentation	Board master	Tarjeta de potencia
57b		Scheda di potenza 115/60	Power board	Carte d'alimentation	Board master	Tarjeta de potencia
58	2W000-05310	Supporto guida DX scheda di potenza	Right guideways support for power board	Support glissière droite pour carte d'alimentation	Rechte Halterung der Leistungsplatine	Soporte guía DCHA tarjeta de potencia
59	2W000-00200	Pannello laterale DX	Right side panel	Panneau latéral droit	Rechte Seitenwand	Panel lateral DCHA
59	2W000-00201	Pannello nero laterale DX	Black right side panel	Panneau noir latéral droit	Rechte schwarze Seitenwand	Panel negro lateral DCHA
60	2U000-01000	Vite di regolazione densità	Density adjustment screw	Vis de régulation densité	Regulierschraube	Tornillo regulador densidad

61	2W000-03400	Blocchetto guidamolla	Shaped nut	Ecrou-guide du ressort	Führung für Feder	Tuerca-guida del muelle
62	2W000-02800	Molla	Spring	Ressort	Feder	Muelle
63	22800-22401	Boccola anteriore grigia	Grey front bushing	Douille anteriore grise	Grey front bushing	Buje gris anterior
64	2U000-10100	Microinterruttore	Microswitch	Microinterrupteur	Mikroschalter	Microinterruptor
65	2W000-05110	Isolante tra spalla e piano raccogli condensa	Insulating between shoulder and post. et égouttoir	Isolation entre parois supérieur	Isolierung zwischen Rückwand und Wanne zum Auffangen des Kondenswassers	Aislante entre panel posterior y plataforma de recogida de agua de condensación
66a		Pannello lato opposto rubinetto	Opposite faucet side panel	Panneau côté opposé au robinet	Verkleidung der Zapfahn-Rückseite	Panel lado opuesto grifo
66b		Pannello nero lato opposto rubinetto	Black opposite faucet side panel	Panneau noir côté opposé au robinet	Verkleidung schwarzer Zapfahn-opuesto Rückseite	Panel negro lado der Zapfahn-opuesto grifo
67		Convogliatore per evaporatore	Evaporator conveyor	Évaporateur convoyeur	Verdampferförderer	Transportador del evaporador
68	22800-07600	Motore ventilatore 230/50	Fan motor	Moteur du ventilateur	Ventilatormotor	Motor ventilador
68	22800-07601	Motore ventilatore 115/60	Fan motor	Moteur du ventilateur	Ventilatormotor	Motor ventilador
69		Filtro rigido condensatore	condenser filter	Filtere du condenseur	Kondensatorfilter	Filtro del condensador
		Vedere tabella	See table	Voir tableau	Siehe Tabelle	Ver tabla
	::	Ordinare con sigla riportata sul pezzo	Please order what printed on piece	Mentionner indicatif imprimé sur la pièce	Diese Teile bitte anhand der aufgedruckten Nummern bestellen	Pedir com la identificación marcada en la pieza



	ICON 1	ICON 2	ICON 3
26a	KQ000-04604	KQ000-04604	-
26b	-	-	KQ000-04603
45a	2W000-00100	2W000-05500	2W000-05600
45b	2W000-00101	2W000-05501	2W000-05601
57a	22700-00610	22700-00620	22700-00630
57b	22700-00611	22700-00621	22700-00631
66a	2W000-00400	2W000-05700	2W000-05800
66b	2W000-00401	2W000-05701	2W000-05801
67	2W000-03200	2W000-03210	2W000-03220
69	2W000-05200	2W000-05210	2W000-05220