



ELECTRIC OVEN

USE AND INSTRUCTION MANUAL

08560350 (3 x 1/1 GN)

08560450 (4 x 1/1 GN)

Index

1. Technical service
2. General warnings
3. Technical specifications
4. Instructions for the installer
5. Use instructions (for the user)
6. Residual risks (for the user)
7. How to use the control panel
8. Ignition
9. Switch-off
10. Operation mode
11. Cooking cycle ON/OFF
12. Displaying / changing parameters with the cooking cycle ON
13. Delayed start to the cooking cycle
14. "Programmed" mode
15. Saving cooking programs
16. Cooking with a saved program
17. Manual humidifying
18. Door device
19. Black – out
20. Oven cooking
21. Routine cleaning and maintenance
22. Possible faults
23. Technical assistance
24. Informations to the consumers
25. Wiring layouts
26. The Warranty
27. Availability and supply of spare parts

1. Technical service

A technical check-up once or twice a year helps prolong the life of the appliance and guarantees better operation. Make sure that assistance is carried out solely and exclusively by qualified personnel. For any spare parts orders or for any information about the appliance, always mention the serial number and model (data indicated on the "technical data" plate at the rear of the oven).

2. General warnings

Very important!: keep this instruction book together with the appliance for future consultation. These warnings were drafted for your safety and for that of others. Please read them carefully before installing or using the appliance:

- If, on receipt of the goods, the **packaging** is damaged, write the following on the delivery note: **"I REVERSE THE RIGHT TO CONTROL THE GOODS"**, specify the damage and get the driver to sign in acceptance; send a claim in writing to the seller within 4 calendar days from the date of receipt. No claim shall be accepted after such period.
- The warehouse inside temperature must not be lower than -9°C; otherwise, the thermostat (regulation and safety thermostat) control devices of the machine will be damaged. Failure to observe this prohibition invalidates any responsibility of the manufacturer of the machine.
- The appliance is intended for professional use and must be utilised by qualified personnel trained to use it.
- Any modification which may be necessary on the electrical system to enable installation of the appliance, must be carried out solely by competent personnel.
- It is dangerous to modify or attempt to modify the characteristics of this appliance.
- Never clean the appliance with direct water jets, because, if any water enters, it could limit the machine's safety .
- Before doing any maintenance or cleaning jobs, disconnect the appliance from the electrical mains and allow it to cool.
- When the tilting door is wide open, do not put anything on the surface, because the door hinges could be irreparably damaged.
- Do not attempt to carry out the periodic controls or any repairs by yourself. Contact the nearest Service Centre and use only original spare parts.

N.B.: Improper or incorrect use and failure to observe the installation instructions shall release the manufacture from all responsibility. In this connection, the directives in the "POSITIONING" paragraph must be strictly observed.

3. Technical specifications

Models	08560450	08560350
Dimensions of appliance LxDxH (mm)	790x750x505	790x750x635
Weight (Kg)	44	58
Maximum load per tray (kg)	4 -2	4 - 2
Maximum load (kg)	12 - 6	16 - 8
Convection heating element (kW)	3,5	6
Max. absorbed power (kW)	3,7	6,4
Power supply voltage (V)	230 V (50/60Hz)	230 (50/60Hz) 400 2N (50/60Hz)
Power cable diameter	3x1,5 mm ²	3x4mm - 4x2,5 mm ²
Type of cable	H07RN-F	
Connecting electric cable	Tipo Y	
Class	I	
Degree of protection against humidity	IPX3	
Water pressure (kPa)	100-200	

The noise level of the appliance in operation is below 70 dB (A).

The "technical data" plate is positioned on the side panel of the appliance.

4. Instructions for the installer

The following instructions are aimed at the qualified installer, to ensure that he carries out the installation, adjustment and maintenance operations as correctly as possible and according to current legal regulations. Any operation must be performed with electrical power cut to the appliance.

Before using the appliance, carefully remove the special adhesive film protecting the parts in stainless steel. Do not leave any glue residues on the surfaces. If necessary, remove them at once, with an appropriate solvent.

Fitting the feet - The feet are inside the appliance and must be secured on the four threaded holes on the base. If necessary, the height of the feet can be adjusted by screwing or unscrewing.

Positioning - Position the appliance perfectly horizontally on a table or similar support (the table or support must be at least 85 cm above the floor). Position it at a distance of not less than 10 cm from the side and rear walls, to enable natural ventilating air to circulate freely around it. The appliance is not suitable for embedding and for grouped positioning with other identical appliances.

Electrical connection - The appliance must be connected to the electrical mains according to current legal regulations. Before making the connection, make sure of the following:

- the voltage and frequency values of the power supply system match the values on the "technical data" plate affixed on the appliance;
- the limiting valve and the system are able to support the appliance's load (see the "technical data" plate);
- **the power supply system has an adequate earth connection according to current legal regulations;**
- a omnipolar switch with minimum between-contacts aperture of the overvoltage category III (4000 V), sized to the load and conforming to current legal regulations, is fitted between the appliance and the mains in the direct connection to the mains;
- the omnipolar switch used for connection is easy to reach when the appliance is installed;
- **the yellow/green earth wire is not interrupted by the switch;**
- the power supply, when the appliance is operating, must not deviate from the rated voltage value by $\pm 10\%$;
- make sure that after inserting the power supply cord into the terminal block it does not come into contact with any of the cooking range's hot parts.
- **if the supply cable is damaged then it must be replaced by the manufacturer or by your technical support or by a qualified person to avoid any risk.**

Connection to the water mains - (for ovens predisposed to humidifier solenoid-valve)

The appliance must be fed with softened drinking water, with pressure in the range from 100 to 200 kPa (1.0 - 2.0 bar). Water must have hardness from 0.5°F to 3°F (it is suggestible to use a softener as to avoid the malfunction of the fan, the breakage of the heating element and to reduce the formation of lime inside the cooking chamber). Connection to the water mains should be made through the threaded 3/4" solenoid-valve on the rear (on the bottom) of the appliance, fitting in between a mechanical filter and an on/off tap (before you connect the filter, allow a certain quantity of water to flow out in order to drain any waste from the pipe).

Connection to water tank - (for ovens predisposed to water pump)

To replace electrovalve with water pump (in ovens with optional predisposition to pump), follow the steps below listed (image 1):

- 1) Remove back cover from oven.
- 2) Disconnect wiring cables from electrovalve.
- 3) Disconnect water tube (3) from electrovalve, pressing e keeping pressed the edge of black linking (quick insertion).
- 4) Remove the electrovalve unscrewing the screw that fix it to oven's frame.
- 5) Fix the pump (1) to the frame with the appropriate support (2) and the two screws (4) included.
- 6) Connect the cables previously disconnected from electrovalve to pump.
- 7) Connect the tube previously disconnected from electrovalve to pump's linking.
- 8) Connect the tube (6) with filter and ballast (included in "Pump kit") to pump's apron (7).
- 9) Replace back cover.

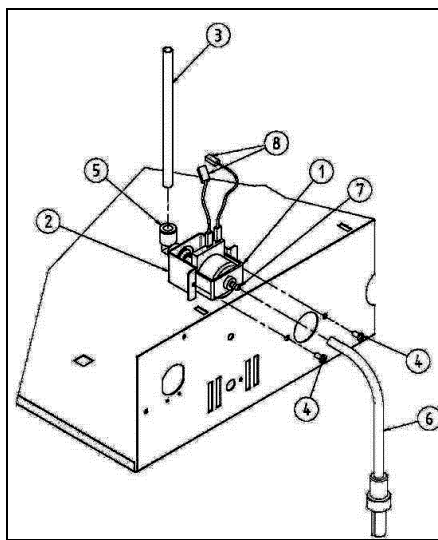

Fig.1

Warning:

To avoid limestone buildup into the cooking chamber, we suggest to fill the water tank with decalcified water.

Check water level in the tank before activating the pump and during its functioning. If pump works without water in the tank, what occurs is abnormal noise at first and then its breakage.

Water drainage (only for MODD. 08560450)

A drain pipe (see Fig. 2) comes out from the rear of the appliance, to drain the oven cavity. This pipe must be connected up to a pipe made to resist steam temperatures (90°C-100°C) with an internal diameter of 30 mm (DN 30). To prevent choking, it is best to use a rigid pipe and make sure there are no "elbow" bends anywhere along the drain line. Furthermore, the drain line must slope down (minimum slope 5%) along its full length (the length in question is from the appliance's drain pipe to the drain point and must not exceed 2 metres). The drain line must run into an open floor drain (Fig. 3). In addition, there must be a free air gap of at least 25 mm (distance between the drain line coming from the appliance and the funnel on the drain standpipe). Whatever the case, in order to comply with current hygiene standards, the line connected to the appliance's drain pipe must not come into direct contact with the drain point. It is advisable to include a suitable trap in the line connecting the appliance's drain outlet to the grey water waste system, thus stopping the steam coming back out of the drain.

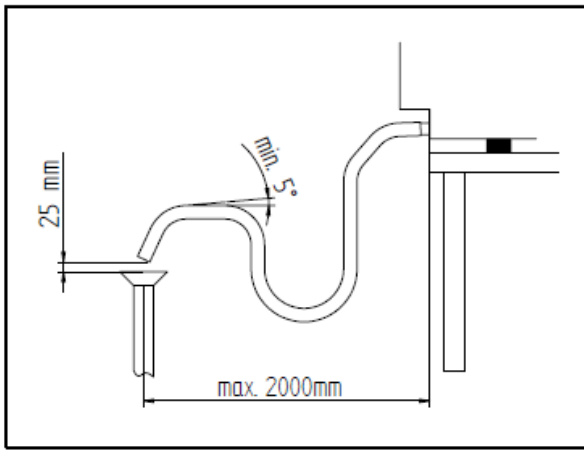

FIG. 2

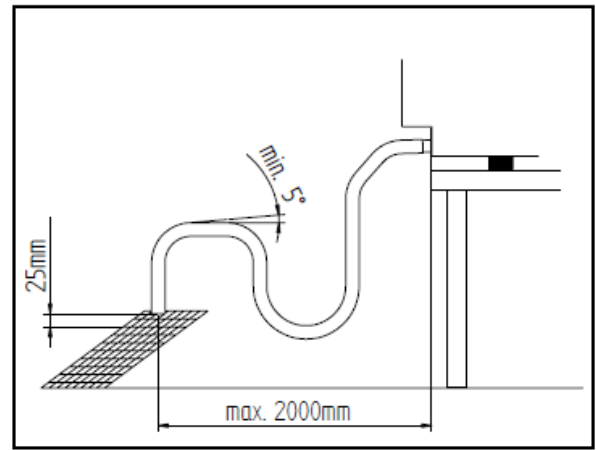

FIG. 3

WARNING

Oven model 08560350 is not equipped with a drain pipe for cooking chamber drainage.

Connecting the power cable:

Mod. 08560350 – To access the terminal board, just remove the appliance's rear side-panel. Loosen the cable gripper and allow the cable to pass through it. Arrange the conductors so that the earth conductor is the last to detach from its terminal if the cable goes into a state of faulty traction. Connect the **phase** conductor to the terminal marked "L1", connecting the **neutral** conductor to the terminal marked "N" and the **earth** conductor to the terminal marked with the symbol \perp . Tighten the cable gripper and re-fit the rear side-panel of the appliance.

Mod. 08560450 To access the terminal board, just remove the appliance's rear side-panel. Loosen the cable gripper and allow the cable to pass through it. Arrange the conductors so that the earth conductor is the last to detach from its terminal if the cable goes into a state of faulty traction. Connect the **phase** conductors to the terminals marked "L1" and "L2", connecting the **neutral** conductor to the terminal marked "N" and the **earth** conductor to the terminal marked with the symbol according to the following lay-out: \perp

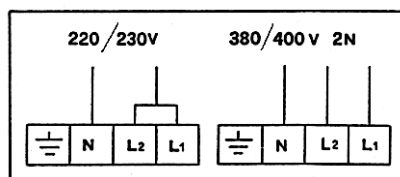

(this electrical connection lay-out is located near the power supply terminal board). Tighten the cable gripper and re-fit the rear side-panel of the appliance.

Any appliance must be connected to an **equipotential system** whose efficiency must first be checked according to current legal regulations.

This connection must be made between different appliances by using the appropriate terminal marked with the symbol \perp . The equipotential conductor must have a minimum diameter of 2,5mm². The equipotential terminal is at the rear of the appliance.

Safety thermal breaker - The appliance is supplied with a manually resetting thermal breaker to protect against excessive, dangerous temperatures which could be accidentally generated inside. If it is tripped, the device cuts off the power supply to the appliance.

5. Use instructions (for the user)

For first use, we advise you to let the appliance to run load-free for 30/40 minutes at a temperature of 200°C. In this way, any unpleasant smells due to thermal insulation and residual work grease are eliminated. This appliance must be used solely for the purpose for which it was expressly designed, i.e. cooking foods in the oven. Any other use is considered unsuitable.

The appliance can be used: for all oven cooking of deserts, pizzas, meat, fish, vegetables, as well as for re-conditioning cooled and frozen foods. When placing food in the cooking compartment, leave a space of at least 40 mm between pans in order not to over-obstruct air circulation. Do not use pans with higher than necessary edges: edges are barriers which prevent the circulation of hot air (for cooking of bread and pastry; do not use pans with borders higher than 20mm, avoid that products into the pan get in contact). Warm up the oven before every cooking operation (set a temperature 30°C higher than cooking temperature) to obtain maximum uniformity. Do not salt foods in the cooking compartment.

6. Residual risks (for the user)

After a cooking operation, open the door cautiously, to avoid a violent outflow of heat which could cause burns. While the oven is in operation, pay attention to the possible hot zones (marked on the appliance) of its external surfaces. Place the machine on a bench or similar support, at a height of at least 85 cm from the floor. The bench or support must be able to support the weight of the machine and house it correctly. The appliance contains electrical parts and must never be washed with a jet of water or steam. The appliance is electrically connected: before attempting any cleaning operation, cut power to the appliance. Do not use the door handle to move the appliance (the glass panel may break). When the tilting door is wide open, there is the risk that things could be placed on the surface with the risk of irreparably damaging the door hinges.

7. How to use the control panel

Control Panel symbol legend:

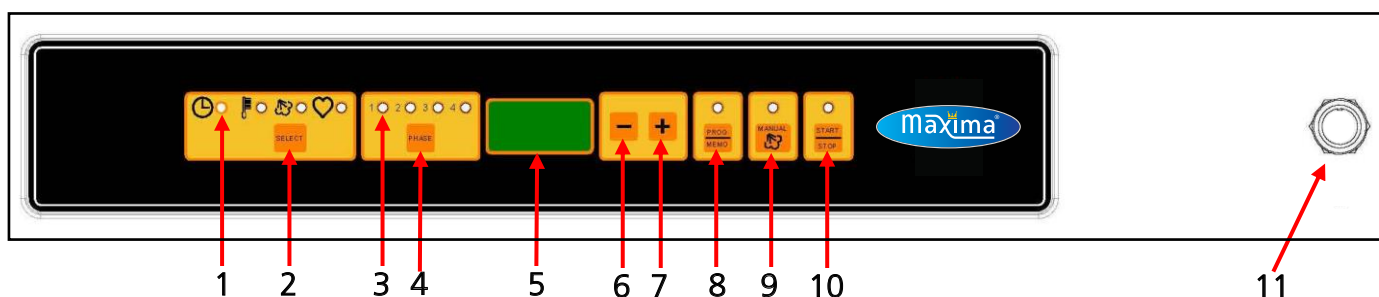

1) Parameter on signal LED	7) Parameter value increase button
2) Cooking parameter selection button	8) Cooking program select/save button
3) Step on signal LED	9) Manual humidifying button
4) Cooking step selection button	10) START/STOP button
5) Parameter display	11) Probe core outlet (for ovens predisposed)
6) Parameter value decrease button	

8. Ignition

The control panel (digital) automatically turns on as soon as the oven is electrically powered. "r.XX" appears on the display for about 2 seconds ("XX" stays for the revision number of the firmware included in the electronic board, for example "r.0.6").

Then "0.00" appears on the display to indicate time (expressed in hours and minutes) and the time led turns on in the parameter field (symbol ).

The phase 1 led turns on in the "phase" field (set to receive cooking parameters).

9. Switch-off

The control panel automatically turns off 10 minutes after the cooking cycle ends (in "manual"

mode or in "automatic" mode whether switched-off automatically or by pressing the  button) without any button being pressed.

The display and operating function leds turn off. Only the  button led remains on.

To restart the control panel, simply press the  button.

10. Operation mode



The cooking cycle can be run in "manual" or "programmed" mode which can be divided in 4 steps. TIME/TEMPERATURE/HUMIDITY/"HEART" TEMPERATURE cooking parameters can be set for each step.

MANUAL MODE

To select cooking parameters (TIME/TEMPERATURE/HUMIDITY/"HEART" TEMPERATURE), press the button  the led for the selected parameter turns on each time the button is pressed. At least cooking time and temperature parameters must be set for the cooking cycle to start.

- To select cooking cycle steps (1 – 2 – 3 – 4), press the button  the led relevant to the selected step turns on each time the button is pressed. The led relevant to the current step blinks during the cooking cycle.

- To set or change the selected parameter, press buttons .

Press button  to increase the parameter. - Press button  to decrease the parameter.

- The time parameter (symbol ) can be set from 0 hours and 01 minutes to 9 hours and 59 minutes. If "INF" or "HLD" appear on the display, this means that the timer is excluded.

The oven operates continuously until manually turned off with the  button.

When "INF" appears on the display (only displayed for step 1), steps 2 - 3 - 4 are disabled (leds off).

When "HLD" appears on the display (only displayed for step 4), this means that the cooking cycle, after terminating the previous steps, continues without the timer and with the parameters set for

phase 4. (The cooking cycle is switched off by pressing the  button). This operation lets the user keep food "warm" (at the end of the cooking cycle) for the desired amount of time.

The temperature parameter (symbol ) can be set from 50° C to 270° C.

The humidity parameter (symbol ) can be set from 0 to 100 (continuous humidity).

The "heart" temperature parameter (symbol ) can be set from 0° C to 100° C (for prepared oven).

N.B.: the "heart" temperature parameter because it is operating must be set before starting the cooking cycle

11. Cooking cycle ON/OFF

The cooking cycle starts and stops by pressing the  button. The resistance, motor and water solenoid valve are switched off at the end of the cooking cycle. The buzzer sounds for 30 seconds and "0.00" blinks on the display. Temperature/humidity parameter settings for the last cycle step remain set.

If an "extra-time" is set during the next 30 seconds, the oven automatically restarts and cooking continues with the temperature and humidity parameters for the last step used. When "extra time" has elapsed, the cooking cycle ends.

If the 30 seconds elapse or the cooking cycle is interrupted by pressing the  button, all set parameters are reset and the oven readies for new cooking cycle settings.

12. Displaying / changing parameters with the cooking cycle ON



When the cooking cycle is on, parameters can be displayed by pressing the  button and values

can be changed (keys ) in each step ( button) in the cooking cycle.



Several seconds after the last change (for any of the four steps) operating step parameters are displayed (led blinks on current step).

If the

"Time" parameter is selected

The value set for the selected step (led on symbol ) is displayed for 4 seconds alternated by the remaining total (COUNT DOWN) for the rest of the other steps for 4 seconds (led blinks on symbol ).



"Temperature" parameter

The value set for the selected step (led on symbol ) is displayed for 4 seconds alternated by the value read in the cooking chamber for 4 seconds (led blinks on symbol ).

"Humidity" parameter

The set value is displayed for the selected step (fixed led on symbol ).



"Heart" temperature parameter (for ovens predisposed)

The display will cycle for 4 seconds, the value set for the selected phase (LEDs mounted on symbol ) and for 4 seconds the measured value within the food (LED flashing on symbol )



N.B.:if you have not connected (in the socket) the thermal probe-shaped pin, instead of reading the writing appears " _ _ _ ".

13. Delayed start to the cooking cycle



To delay the start for the cooking cycle, proceed as follows:

- Set the required parameters for each phase in the cooking cycle, following the instructions in the paragraph "OPERATING METHOD" (paragraph 10).
- Press the  key until all the signal leds go out on the control panel. The message "0.00" appears on the display.
- Press the  keys and set the required "DELAY TIME" on the display (maximum 9 hours and 59 minutes).

- Press the  key to activate the delayed start.

The led on the  key starts flashing to show that the COUNTDOWN has started shown on the display. The DELAY TIME can be changed at any moment during the COUNTDOWN by pressing the  /  keys.

When the DELAY TIME is up, the cooking cycle will start automatically.

To zero the DELAY TIME, just press the  key; the display will show the operating parameters than can be changed. Press the  again to continue the cooking cycle; otherwise a delayed start for the cooking cycle can be reset by proceeding as above.

N.B.: in case of BLACKOUT or power failure during the COUNTDOWN, the programmed delay for the cooking cycle is cancelled and all the relative set parameters are zeroed.





A delayed start to the cooking cycle is only possible in MANUAL MODE. It cannot be included in a programmed cooking cycle.

14. "Programmed" mode

Up to 99 cooking programs (cycles) can be saved. Each program can include 1 or more cooking steps (up to 4).

15. Saving cooking programs

Follow the steps below to save a cooking program:





- press the button  (led on) "P01" appears on the display.
- Press buttons   and select the required program number (up to P99).
- Set the relevant cooking cycle parameters following the same procedure used for "manual" mode.
- Press and hold down the  button for at least 5 seconds: the program is successfully saved with the saved program number blinks on the display.

To cancel a saved program, simply replace it with a new program (with the same number) where new parameters are set for the new cooking cycle. The new program must be saved by pressing the

 button.

16. Cooking with a saved program

Follow the steps below to run a saved cooking program:

- press the button  "P01" appears on the display.
- Press buttons   and select the required program number
- Press button .

"P – H" appears on the display (cooking chamber "preheating" function).

The oven operates until it reaches a temperature equal to the value set for step 1 (programmed cycle) increased by 30°C. When the preheating temperature is reached, "P – H" blinks on the display and the buzzer sounds. At this point, open the oven door, introduce food to be cooked and close the door. the buzzer turns off and the programmed cooking cycle starts.

N.B.: the "preheating" function is available (automatically started) only in "programmed" cooking modes. When the oven is operating in "programmed" mode, set parameters can be displayed in the same way as with "manual" mode. For the user's convenience, set parameters can be changed during oven operations in "programmed" mode.

At the end of the programmed cooking cycle, changed parameters are automatically "RESET" and return to the values initially saved in the program.

17. Manual humidifying

Humidity can be produced in the cooking chamber (water solenoid valve on or activation of water pump) at any time in the cooking cycle (in both "manual" and "programmed" mode) by pressing

the button  (led on). Continuous humidity as long as the button is pressed.

If an automatic humidifying cycle is in progress, press button  (water solenoid valve on or activation of water pump) to interrupt it. Release the automatic humidifying cycle button to resume.

18. Door device

The device stops oven operations (stops the cooking cycle) whenever the door is opened. The cooking cycle resumes where it left off when the door is closed.

19. Black - out

When power returns after a black-out, the oven automatically resumes operations and the cooking cycle resumes from where it left off.

20. Oven cooking

Cooking techniques

There are two different cooking techniques with this oven: convection and convection + humidification.

Convection cooking - Heat is transferred to the foods by pre-heated air, forced to circulate by in the cooking chamber. The heat quickly and uniformly reaches all parts of the chamber, enabling simultaneous cooking of different types of food (providing they have the same cooking temperature), placed on the shelves without mixing tastes and smells. Convection cooking is particularly convenient for rapid de-freezing, and for sterilising preserves and drying mushrooms and fruit.

Cooking Convection + humidification - The fact of using a hot-moist climate inside the cooking chamber with variable temperature and moisture levels, is the most convenient and efficient way of cooking: cooking times are reduced, the surface of the foods remains soft and does not form a crust, there is little weight loss and the fatty mass is reduced.

Cooking with "heart" temperature function (for prepared oven)

The temperature can be set inside the core of the food to be cooked, using the special needle core probe that is supplied with the oven. The probe must be pushed into the centre of the food in the thickest part, avoiding the bones. Place the food inside the cooking chamber and pull out the thermal probe lead and close the oven door. The probe plug must be plugged into the special socket.

- ***Cooking with the parameter "time" set from 01 minutes to 9 hours and 59 minutes***
If during the cooking cycle the thermal probe should go to failure, cooking is still being set for the time.
- ***Cooking with the parameter "time" set as "INF"***
If during the cooking cycle the thermal probe should go to failure, cooking stops permanently
- ***Cooking with some set phases and core probe connected***
Selecting the parameter "time", the display shows alternatively the time set for the active phase and the word "Prb" (confirms that in a phase of the cooking cycle is set the parameter "core temperature")

- **Cooking with some set phases and core probe disconnected.**
Selecting the parameter "time", the display shows alternatively the time set for the active phase and the total time for all stages of the cooking cycle.

The cooking cycle ends when the temperature detected by the probe (introduced in the food) reaches the value sets in the parameter "core temperature" (Regardless of the value of the parameter "time")

Warning: Before removing the food from the oven after cooking with the core needle probe. Carefully remove the hot probe from the cooked food, taking care not to leave it hanging out of the cooking chamber as it could cause burns. We advise leaving it to cool down before using it again – to avoid damaging pricks in the food.
To prevent any irreparable damage to the thermal piercing probe (core probe) do not use it in high temperature cooking ABOVE 230°C, and ensure that the probe lead is not touching any hot metal surfaces inside the oven.

21. Routine cleaning and maintenance

(WARNING: Cut power to the appliance before every operation)

General cleaning - Clean the oven when it is cold. Wash enamelled parts with lukewarm water and soap, do not use abrasive products, steel wool, or acids, which could ruin them. To clean the steel parts, do not use products containing chlorine (sodium hypochlorite, hydrochloric acid, etc) even if diluted. Use specific off-the-shelf products or a little hot vinegar. Rinse thoroughly with water and dry with a soft cloth. Clean the glass door of the oven with hot water only, and do not use rough cloths. Do not allow foods (especially acid foods such as salt, vinegar, lemon, etc) to stagnate on the stainless steel parts, because they could deteriorate. Do not wash the appliance with direct jets of water, because if water enters, this could limit the appliance's safety. Do not use corrosive substances (e.g. hydrochloric acid) to clean the oven's support bench.

Cleaning the oven - It is good practice to clean the oven interior at the end of every day of duty. In this way it will be easier to remove cooking residues, preventing them from burning when the oven is next used. Clean it accurately with hot water and soap or with the appropriate off-the-shelf products.

Cleaning the oven door – (Except mod. 08560450)

To clean the oven door thoroughly, proceed as follows:

- fully open the door;
- insert the equipped plugs in the "A" holes on the hinges (Fig. 4);
- lift the door gently and withdraw it (Fig. 5);
- put back the door in the initial position by operating inverserly.

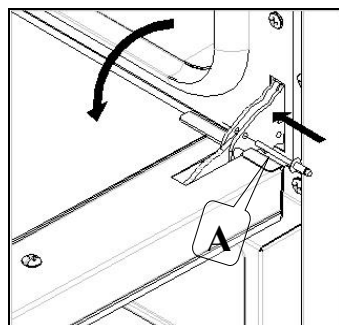

Fig. 4

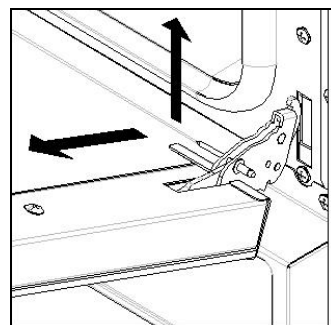



Fig. 5

Replacing oven lamp - Electrically switch off the appliance; unscrew the protective glass cap with the corresponding rings for airproofing; unscrew the lamp and replace it with another lamp suitable for high temperatures (300°C), with the following characteristics:

- Voltage 230/240 V
- Power 15 W
- Fitting E 14

Refit the glass cap with the corresponding rings for airproofing and power up the appliance.

22. Possible faults

Type of fault	Cause	Corrective action
Control panel completely off (the oven does not work)	- Incorrect electric connections to the mains	- Check the mains connection
	- No mains voltage	- Restore mains voltage
	- Thermal break safety device tripped	- Reset the thermal break safety device
	- Electronic card protection fuse (control panel) burnt	- Contact a qualified technician
Cooking cycle set and  push button pressed: the oven does not work	- Door open or ajar	- Close the door
	- Damaged door switch device	- Contact a qualified technician to repair the sensor
Humidity production in cooking chamber on: No water flows from the pipes (on the fans)	- Incorrect connection to water mains	- Check the connection to water mains (electrovalve) or the connection of pump
	- Connection of non-conforming pump	- Check the connection to water mains (electrovalve) or the connection of pump
	- Cut-off cock closed (electrovalve)	- Check the cut-off cock
	- Tank without water (pump)	- Check water level into the tank
Door closed: water / vapour comes out of the seal	- Blocked water inlet filter	- Clean the filter
	- Electrovalve or pump water entrance damaged	- Contact a qualified technician to repair the solenoid
	- Seal not fitted correctly	- Check the seal fitting
	- Damaged seal	- Contact a qualified technician to repair the seal
The oven does not cook evenly	- Handle mechanism loosened (lateral opening door)	- Contact a qualified technician to repair the prong
	- One of the motors is blocked or turns slowly (If the oven has two motors)	- Contact a qualified technician to repair the motor
	- The motors do not go into reverse	- Contact a qualified technician to repair the motor
Lighting lamp in the cooking chamber does not work	- Heating element not powered or is damaged	- Contact a qualified technician to repair the element
	- Damaged lamp	- Change the lamp
"ER1" appears on the display	- Light bulb "unscrewed"	- Make sure the light bulb is fully screwed-in.
	- Breaking in the connection between the cooking chamber probe (electronic card) and the control panel	- Check the connection to the control panel
(for ovens predisposed) Core temperature activated (led on to the symbol ) and probe connected to the control panel: the message " - - - " appears on the display	- Damaged cooking chamber probe	- Contact a qualified technician to repair the probe
	- Break in the connection between the core probe – electronic (power) card	- Check the connection to the electronic card
	- Damaged core needle probe	- Contact a qualified technician to repair the probe

23. Technical assistance

Before leaving the factory, the appliance was completely regulated and tested by expert specialised personnel to guarantee the best operating results.

All repairs and settings must be performed with utmost care and attention, respecting national safety regulations in force. Always contact your retailer or our nearest Service Centre, giving details of the problem, the appliance model and the serial number (on the rating plate on the rear panel).

For any maintenance the user can contact **Maxima Kitchen Equipment** by calling the telephone numbers on the cover or going to www.maximakitchenequipment.com..

24. Informations to the consumers

Further to Directive 2012/19/UE, the symbol of the crossed rubbish skip on the appliance means that at the end of its life, the product must be disposed of separately from the other rubbish. The user must hand the appliance to a specialised waste collection centre for electric and electronic equipment.

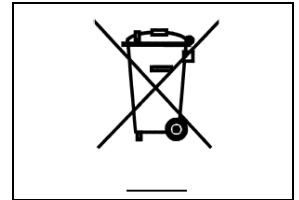

The separate collection of the rubbish and subsequent treatment, recovery and disposal help to produce other equipment using recycled materials, reducing the negative effects on the environment and public health, which would be caused by incorrect management of the rubbish.

Should the user dispose of the product abusively, administrative sanctions would be applied pursuant.

Maxima Digital Deluxe Combisteamer 3 x 1/1 GN

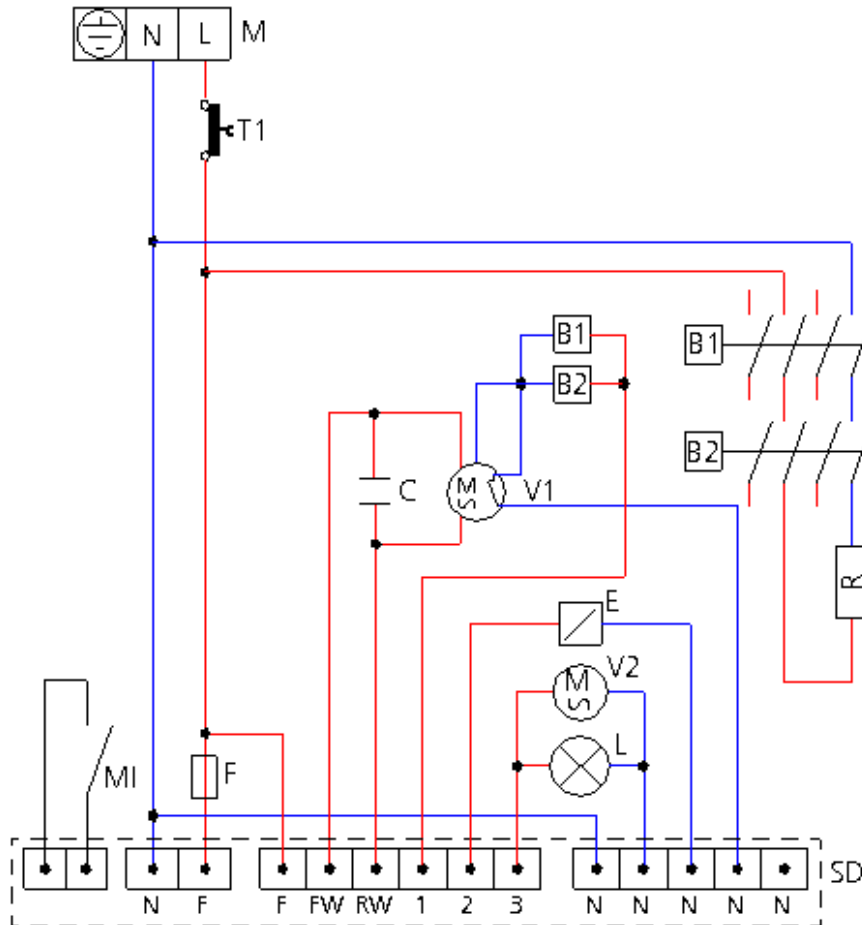

Key

M	Power terminal board	B1-B2	Contactor coils
T1	Safety thermostat	R	Circular heating-element
SD	Electronic card	V1	Oven motorised ventilator
MI	Door microswitch	V2	Tangential motorised ventilator
F	Fuse	C	Capacitor
E	Humidifier solenoid-valve	L	Oven lighting lamp

Maxima Digital Deluxe Combisteamer 4 x 1/1 GN

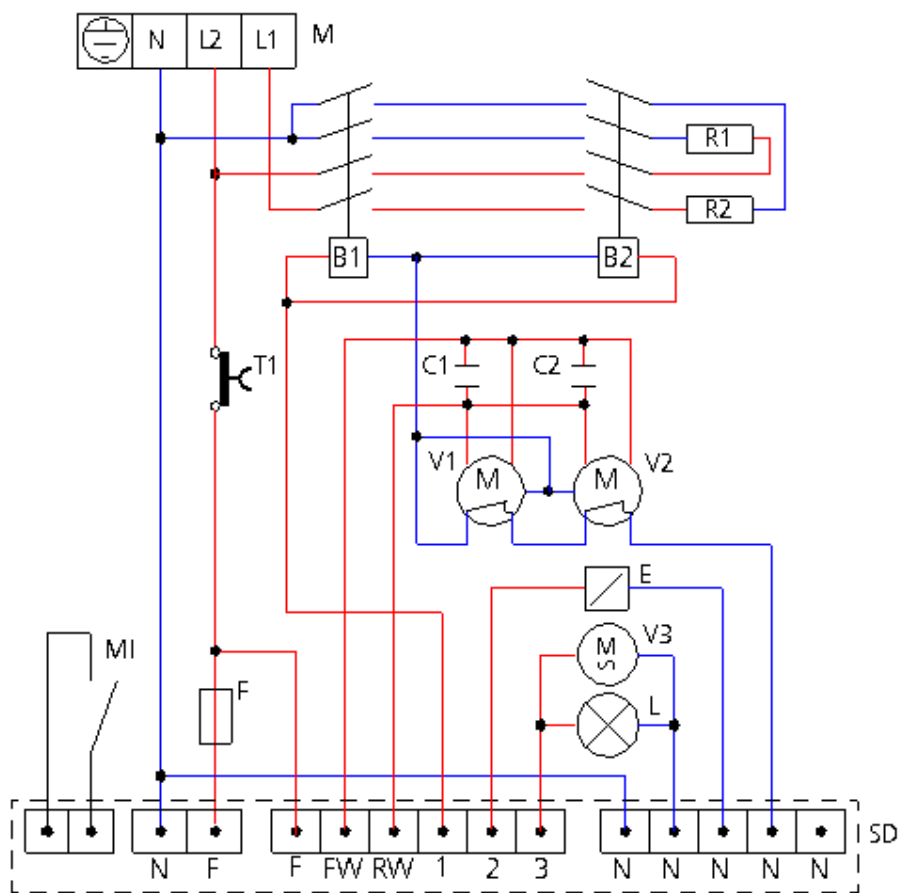

Key

M	Power terminal board	B1-B2	Contactors coils
T1	Safety thermostat	R1-R2	Circular heating-element
SD	Electronic card	V1-V2	Oven motorised ventilator
MI	Door microswitch	V3	Tangential motorised ventilator
E	Humidifier solenoid-valve	C1-C2	Capacitor
F	Fuse	L	Oven lighting lamp

26. Established warranty

Maxima Kitchen Equipment products are exclusively designed for food use and are covered by warranty complying with Laws Regulation article n. 1490 and following) for professional users such as VAT holder customers purchasing from Distributor.

Maxima Kitchen Equipment products are professional and certified according to the IEC 60335-1 standards and can only be sold to professional users.

With the exclusion of any additional warranty, the Seller will repair, at its sole discretion, only those parts of its products which prove vitiated by an original defect provided that, subject to revocation, the customer has reported the defect within 12 months from 'purchase and reported the defect within 8 (eight) days of the discovery, in writing enclosing a copy of the invoice, receipt or sales receipt proving the purchase.

As well as in the event that the customer is not able to produce the invoice, receipt or sales receipt proving the purchase or are not respected the terms outlined above, the guarantee is expressly excluded in the following cases:

- 1) Any failure or breakage of components caused by transport.
- 2) Damage caused by inadequate electrical, plumbing and gas installation than provided in the installation manual, or by an abnormal function of the same.
- 3) Damage resulting from incorrect installation of the product, or installation not in accordance with the requirements in the installation manual, and in particular damage due to failure of the chimneys and the discharges which this product is connected.
- 4) Product use for purposes other than those it is intended for, as specified and resulting from the technical documentation released by Maxima Kitchen Equipment.
- 5) Damage caused by use of the Product not in accordance with instructions contained in the user and maintenance manual.
- 6) Product tampering.
- 7) Adjustment Operations, maintenance and repair of the product performed by unqualified personnel.
- 8) Use of non-original or not authorized parts by Maxima Kitchen Equipment.
- 9) Damage or defect caused by negligent and / or reckless of the product, or in contrast with the instructions prescribed by the instruction and maintenance manual.
- 10) Damage caused by a fire or other natural events and in any case any damage by accident or addicted to any cause not dependent on the manufacturer.
- 11) Damage to parts subject to normal wear that need to be replaced periodically.

Also excluded from the guarantee: the painted or enameled parts, knobs, handles, mobile or removable plastic parts, light bulbs, glass parts, seals, electronic parts, and all the possible accessories, transport costs from the based consumer, the end user and / or purchaser to the seat of Maxima Kitchen Equipment. and vice versa. The warranty doesn't include also the oven's replacement costs and the related installation costs. The warranty excludes products purchased as used or purchased from third parties not connected or authorized by Maxima Kitchen Equipment is not responsible for damages, direct or indirect, caused by the product failure, or following to the forced suspension of use of the same.

Warranty repairs do not result in the extension or renewal thereof.

Parts replaced under warranty are in turn a guarantee of 6 months from the date of shipment, attested by a movement document issued by Maxima Kitchen Equipment.

Nobody is authorized to modify the terms and conditions of guarantee or to release other verbal or written.

27. Availability and supply of spare parts

Maxima Kitchen equipment guarantees the supply of spare parts for a period not exceeding 12 months from the invoice date of the appliance purchased. After that date, availability of spare parts cannot be guaranteed.

The products included on manuals may be subject, without any notice or responsibility for Maxima Kitchen Equipment, to technical and functional design changes aiming at improvements without compromising their essential functional and safety features. Maxima Kitchen Equipment is not responsible for any inaccuracies due to bad printing or transcription errors, that could appear on any tool of presentation and/or technical and commercial description of its products to customers.



WWW.MAXIMAHOLLAND.COM
INFO@MAXIMAHOLLAND.COM
+31 (0) 297 253 969

SHOWROOM:

NIJVERHEIDSWEG 19F
3641 RP MIJDRECHT
THE NETHERLANDS

**OFFICE, TECHNICAL
SERVICE DEPARTMENT &
SPAREPART WAREHOUSE:**

NIJVERHEIDSWEG 23A/23C
3641 RP MIJDRECHT
THE NETHERLANDS