

**NordCap®**

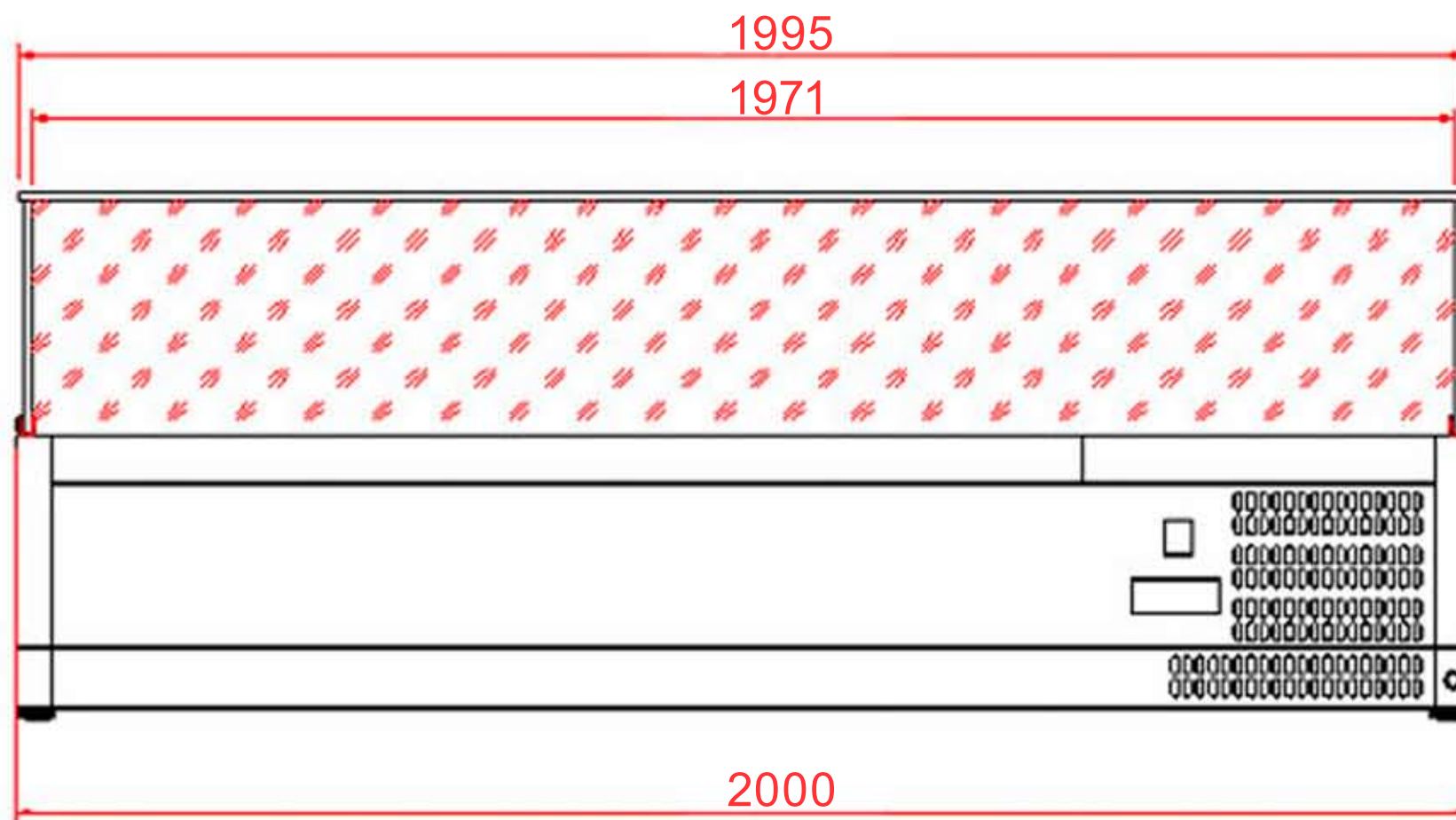
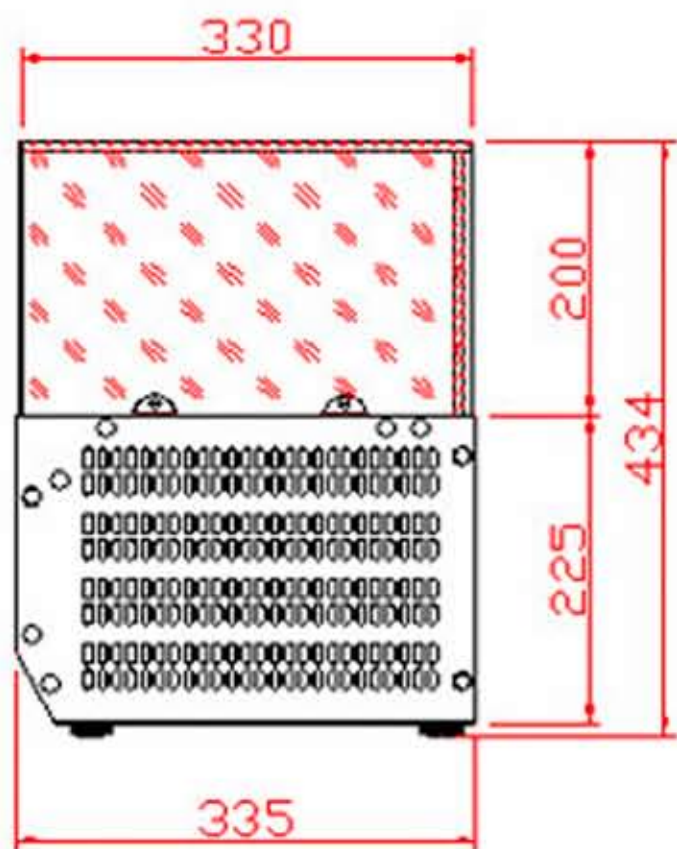

	Date: 140413
Model: VK33-200	Rev.: 01
Dimensions	Rev. by: rfj
Drawing no.:	