

Masszeichnung

COOL-LINE-Freikühltheke PATAGONIA 250 ST BLACK

[Art. 506110250]

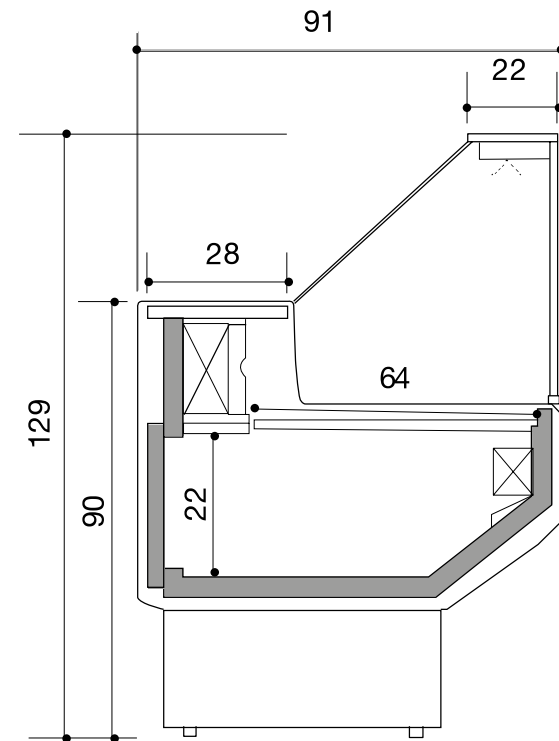
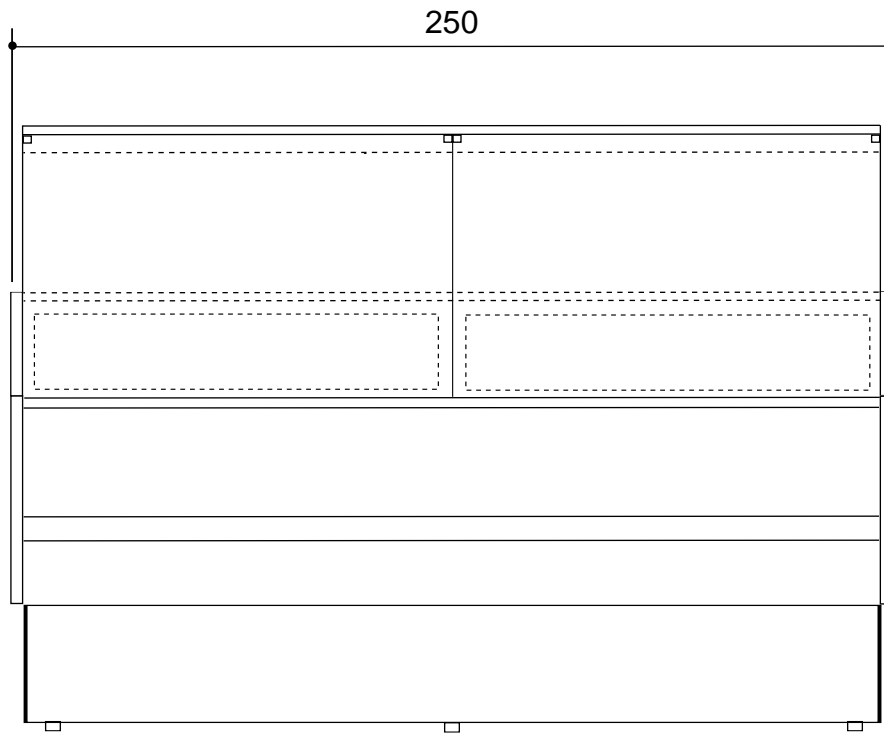

* Alle Angaben in cm