

Masszeichnung

COOL-LINE-Freikühltheke PATAGONIA 200 ST BLACK

[Art. 506110200]

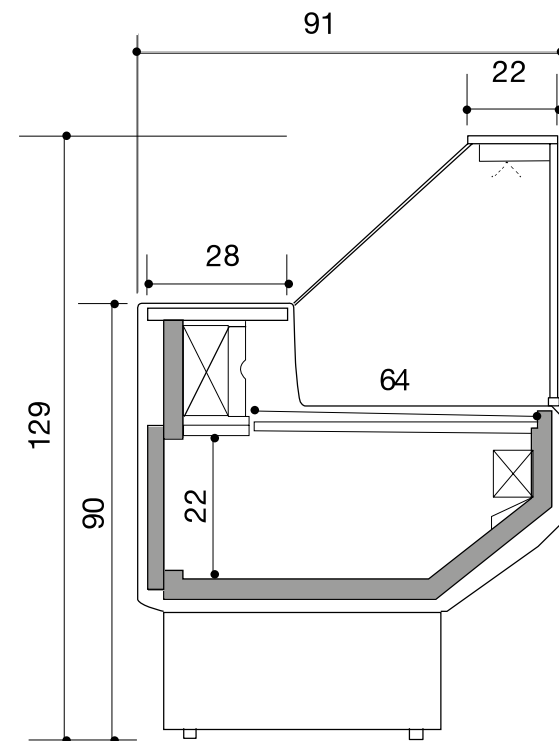
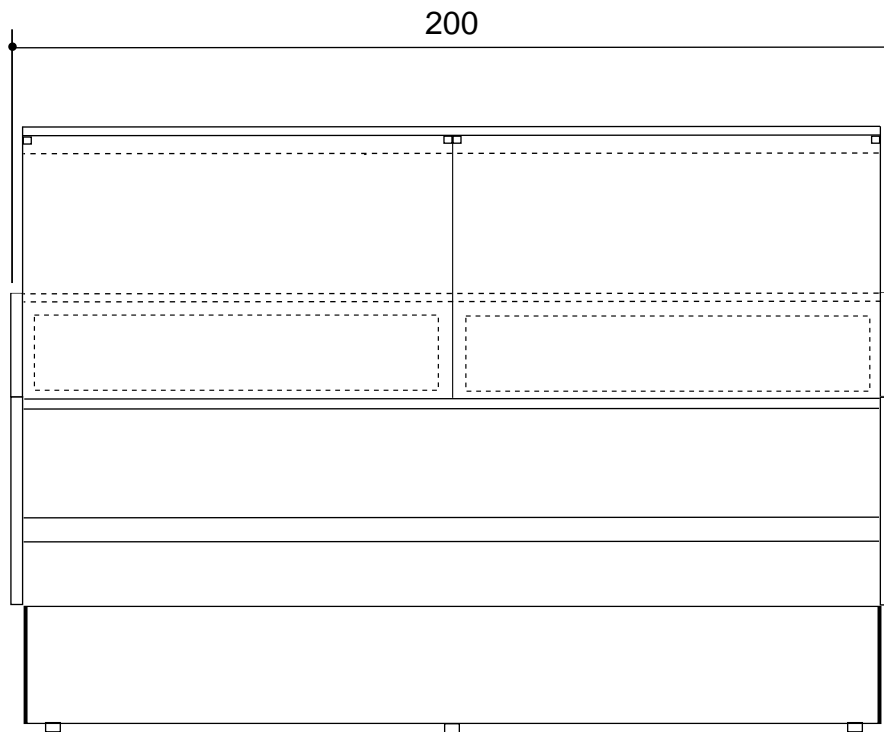

* Alle Angaben in cm